

# SONY®

## Digital Still Camera

### Operating Instructions

Before operating the unit, please read this manual thoroughly, and retain it for future reference.

### Owner's Record

The model and serial numbers are located on the bottom. Record the serial number in the space provided below. Refer to these numbers whenever you call upon your Sony dealer regarding this product.

Model No. DSC-F717

Serial No. \_\_\_\_\_

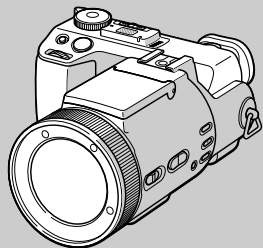

## DSC-F717

### Cyber-shot

Digital Still Camera



MEMORY STICK™

3-078-045-14(2)

Getting started \_\_\_\_\_

Shooting still images \_\_\_\_\_

Viewing still images \_\_\_\_\_

Deleting still images \_\_\_\_\_

Before advanced operations \_\_\_\_\_

Advanced still image shooting \_\_\_\_\_

Advanced still image viewing \_\_\_\_\_

Still image editing \_\_\_\_\_

Enjoying movies \_\_\_\_\_

Enjoying images on your computer \_\_\_\_\_

Troubleshooting \_\_\_\_\_

Additional information \_\_\_\_\_

Index

## WARNING

To prevent fire or shock hazard, do not expose the unit to rain or moisture.

## For the Customers in the U.S.A.

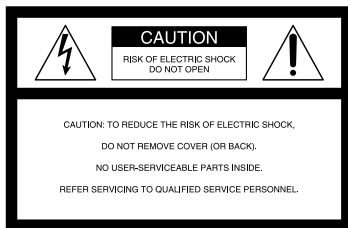

This symbol is intended to alert the user to the presence of uninsulated “dangerous voltage” within the product’s enclosure that may be of sufficient magnitude to constitute a risk of electric shock to persons.



This symbol is intended to alert the user to the presence of important operating and maintenance (servicing) instructions in the literature accompanying the appliance.

## CAUTION

The use of optical instruments with this product will increase eye hazard. Use of controls or adjustments or performance of procedures other than those specified herein may result in hazardous radiation exposure.

If you have any questions about this product, you may call:

Sony Customer Information Center  
1-800-222-SONY (7669)

The number below is for the FCC related matters only.

## Regulatory Information

### Declaration of Conformity

Trade Name: SONY  
Model No.: DSC-F717  
Responsible Party: Sony Electronics Inc.  
Address: 680 Kinderkamack Road,  
Oradell, NJ 07649 USA  
Telephone No.: 201-930-6972

This device complies with Part 15 of the FCC Rules. Operation is subject to the following two conditions: (1) This device may not cause harmful interference, and (2) this device must accept any interference received, including interference that may cause undesired operation.

## CAUTION

You are cautioned that any changes or modifications not expressly approved in this manual could void your authority to operate this equipment.

### Note:

This equipment has been tested and found to comply with the limits for a Class B digital device, pursuant to Part 15 of the FCC Rules. These limits are designed to provide reasonable protection against harmful interference in a residential installation. This equipment generates, uses, and can radiate radio frequency energy and, if not installed and used in accordance with the instructions, may cause harmful interference to radio communications. However, there is no guarantee that interference will not occur in a particular installation. If this equipment does cause harmful interference to radio or television reception, which can be determined by turning the equipment off and on, the user is encouraged to try to correct the interference by one or more of the following measures:

- Reorient or relocate the receiving antenna.
- Increase the separation between the equipment and receiver.
- Connect the equipment into an outlet on a circuit different from that to which the receiver is connected.
- Consult the dealer or an experienced radio/TV technician for help.

The supplied interface cable must be used with the equipment in order to comply with the limits for a digital device pursuant to Subpart B of Part 15 of FCC Rules.

## For the Customers in the U.S.A. and Canada

### RECYCLING LITHIUM-ION BATTERIES

Lithium-Ion batteries are recyclable.

You can help preserve our environment by returning your used rechargeable batteries to the collection and recycling location nearest you.



For more information regarding recycling of rechargeable batteries, call toll free 1-800-822-8837, or visit <http://www.rbc.org/>



**Caution:** Do not handle damaged or leaking Lithium-Ion batteries.

### CAUTION

TO PREVENT ELECTRIC SHOCK, MATCH WIDE BLADE OF PLUG TO WIDE SLOT, FULLY INSERT.

## Notice on the supplied AC power adaptor for the customers in the United Kingdom

A moulded plug complying with BS 1363 is fitted to this equipment for your safety and convenience.

Should the fuse in the plug supplied need to be replaced, a 5 AMP fuse approved by ASTA or BSI to BS 1362, (i.e., marked with  or  mark) must be used.

If the plug supplied with this equipment has a detachable fuse cover, be sure to attach the fuse cover after you change the fuse. Never use the plug without the fuse cover. If you should lose the fuse cover, please contact your nearest Sony service station.

## Attention for the Customers in Europe

This product has been tested and found compliant with the limits sets out in the EMC Directive for using connection cables shorter than 3 meters (9.8 feet).

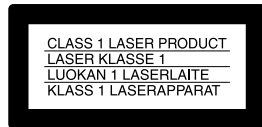

This statement is indicated under the lens.

### Attention

The electromagnetic field at the specific frequencies may influence the picture and sound of this camera.

### Notice

If static electricity or electromagnetism causes data transfer to discontinue midway (fail), restart the application or disconnect and connect the USB cable again.



### For the Customers in the U.S.A. and Canada

THIS DEVICE COMPLIES WITH PART 15 OF THE FCC RULES. OPERATION IS SUBJECT TO THE FOLLOWING TWO CONDITIONS:

- (1) THIS DEVICE MAY NOT CAUSE HARMFUL INTERFERENCE, AND
  - (2) THIS DEVICE MUST ACCEPT ANY INTERFERENCE RECEIVED, INCLUDING INTERFERENCE THAT MAY CAUSE UNDESIRE OPERATION.
- THIS CLASS B DIGITAL APPARATUS COMPLIES WITH CANADIAN ICES-003.

## Before using your camera

### Trial recording

Before you record one-time events, you may want to make a trial recording to make sure that the camera is working correctly.

### No compensation for contents of the recording

Contents of the recording cannot be compensated for if recording or playback is not possible due to a malfunction of your camera or recording media, etc.

### Notes on image data compatibility

- This camera conforms with the Design rule for Camera File system universal standard established by the JEITA (Japan Electronics and Information Technology Industries Association).
- Playback of images recorded with your camera on other equipment and playback of images recorded or edited with other equipment on your camera are not guaranteed.

### Precaution on copyright

Television programs, films, video tapes, and other materials may be copyrighted. Unauthorized recording of such materials may be contrary to the provision of the copyright laws.

### Do not shake or strike the camera

In addition to malfunctions and inability to record images, this may render the “Memory Stick” unusable or image data breakdown, damage or loss may occur.

### LCD screen, LCD finder (only models with an LCD finder) and lens

- The LCD screen and the LCD finder are manufactured using extremely high-precision technology so over 99.99% of the pixels are operational for effective use. However, there may be some tiny black points and/or bright points (white, red, blue or green in color) that constantly appear on the LCD screen and the LCD finder. These points are normal in the manufacturing process and do not affect the recording in any way.
- Be careful when placing the camera near a window or outdoors. Exposing the LCD screen, the finder or the lens to direct sunlight for long periods may cause malfunctions.

### Do not get the camera wet

When taking pictures outdoors in the rain or under similar conditions, be careful not to get the camera wet. If moisture condensation occurs, see page 113 and follow the instructions on how to remove it before using the camera.

### Back up recommendation

To avoid the potential risk of data loss, always copy (back up) data to a disk.

### Do not aim the camera at the sun or other bright light

This may cause irrecoverable damage to your eyes. Or it may cause the malfunction of your camera.

### The pictures used in this manual

The photographs used as examples of pictures in this manual are reproduced images, and are not actual images shot using this camera.

### Trademarks

- “Memory Stick,”  and “MagicGate” are trademarks of Sony Corporation.
- “Memory Stick Duo” and **MEMORY STICK DUO** are trademarks of Sony Corporation.
- “Memory Stick PRO” and **MEMORY STICK PRO** are trademarks of Sony Corporation.
- “MagicGate” and **MAGICGATE** are trademarks of Sony Corporation.
- “InfoLITHIUM” is a trademark of Sony Corporation.
- Microsoft and Windows are registered trademarks of the U.S. Microsoft Corporation in the United States and other countries.
- Macintosh, Mac OS, QuickTime, iBook and Power Mac are trademarks or registered trademarks of Apple Computer, Inc.
- Pentium is a trademark or a registered trademark of Intel Corporation.
- In addition, system and product names used in this manual are, in general, trademarks or registered trademarks of their respective developers or manufacturers. However, the <sup>TM</sup> or ® marks are not used in all cases in this manual.

### About the Carl Zeiss lens

This camera is equipped with a Carl Zeiss lens which is capable of reproducing fine images. The lens for this camera uses the MTF\* measurement system for cameras developed jointly by Carl Zeiss, in Germany, and Sony Corporation, and offers the same quality as other Carl Zeiss lenses.

\* MTF is an abbreviation of Modulation Transfer Function, a numeric value indicating the amount of light from a specific part of the subject gathered at the corresponding position in the image.

# Table of contents

Before using your camera .....	4
Identifying the parts .....	8

## Getting started

Charging the battery pack .....	11
Using an external power source .....	14
Using your camera abroad .....	14
Turning on/off your camera .....	15
How to use the control button .....	15
Setting the date and time .....	16

## Shooting still images

Inserting and removing a “Memory Stick” .....	18
Setting the still image size .....	19
Basic still image shooting (using auto adjustment mode) .....	20
Checking the last image you shot — Quick Review .....	21
Shooting images with the finder .....	22
Indicators on the screen during shooting .....	22
Using the zoom feature .....	23
Changing the lens orientation .....	24
Shooting close-ups — Macro .....	24
Using the self-timer .....	25
Selecting a flash mode .....	26
Inserting the date and time on a still image .....	28

Shooting according to scene conditions — Scene Selection .....	29
Setting the still image quality .....	31
Image size and quality .....	32

## Viewing still images

Viewing images on the screen of your camera .....	33
Viewing images on a TV screen .....	35

## Deleting still images

Deleting images .....	37
Formatting a “Memory Stick” .....	40

## Before advanced operations

How to setup and operate your camera ..	42
Changing the menu settings .....	42
Changing the items in the SET UP screen .....	42
How to use the jog dial .....	43

## Advanced still image shooting

Shooting with the manual adjustments ..	44
Shutter speed priority mode .....	44
Aperture priority mode .....	45
Manual exposure mode .....	45

Choosing a focus method .....	46
Shooting with AF lock .....	47
Focusing manually .....	48
Adjusting the exposure — EV adjustment .....	49
Displaying a histogram .....	50
Metering mode .....	51
Shooting with the exposure fixed — AE LOCK .....	52
Shooting three images with the exposure shifted — Exposure Bracket .....	53
Adjusting color tones — White Balance .....	54
Shooting in the dark .....	55
NightShot .....	56
NightFraming .....	56
Shooting multiple frames — Clip Motion .....	57
Shooting in Multi Burst mode — Multi Burst .....	58
Shooting three images continuously — Burst .....	59
Shooting still images in TIFF mode — TIFF .....	60
Shooting still images for e-mail — E-mail .....	61
Shooting still images with audio files — Voice .....	61

Adding special effects	
— Picture Effect .....	62
Using an external flash .....	63
Using the Sony HVL-F1000 Flash .....	63
Using a commercially available external flash .....	63
Selecting a folder .....	64
Creating a new folder .....	64
Changing the recording folder .....	65

## Advanced still image viewing

Selecting a playback folder .....	66
Enlarging a portion of a still image .....	66
Enlarging an image	
— Playback zoom .....	67
Recording an enlarged image	
— Trimming .....	67
Playing back successive images	
— Slide Show .....	68
Rotating still images .....	69

## Still image editing

Protecting images — Protect .....	70
Changing image size — Resize .....	72
Choosing images to print	
— Print (DPOF) mark .....	72

## Enjoying movies

Shooting movies .....	75
Viewing movies on the screen .....	76
Deleting movies — Delete .....	77
Editing movies .....	79
Cutting movies .....	79
Deleting unnecessary portions of movies .....	80

## Enjoying images on your computer

Copying images to your computer	
— For Windows users .....	81
Copying images to your computer	
— For Macintosh users .....	90

## Troubleshooting

Troubleshooting .....	92
Warnings and messages .....	101
Self-diagnosis display .....	103



## Additional information

Number of images that can be saved or shooting time .....	104
Menu items .....	106
SET UP items .....	110
Precautions .....	113
On “Memory Stick” .....	114
On “InfoLITHIUM” battery pack .....	115
Specifications .....	116
FINDER/LCD screen .....	118
Index .....	121

# Identifying the parts

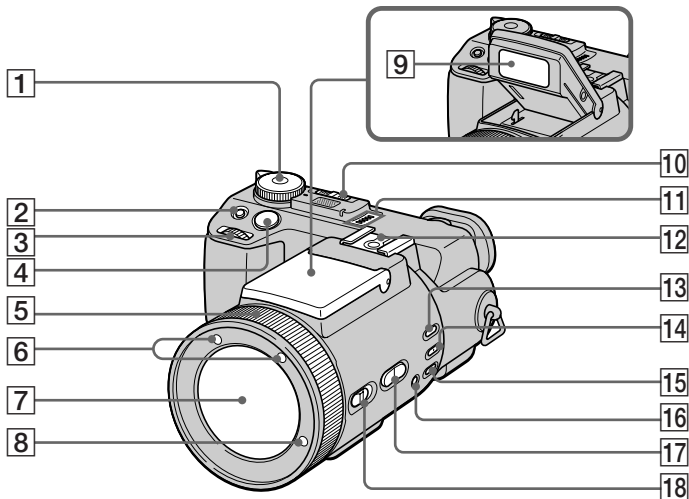
See the pages in parentheses for details of operation.



- 2  (exposure) button (49)
- 3 **Jog dial** (43)
- 4 **Shutter button** (20)
- 5 **Manual focus/zoom ring** (23, 48)
- 6 **Infrared ray emitter** (55)
- 7 **Lens**
- 8 **Hologram AF emitter** (27, 110)
- 9 **Flash emitter** (26)
- 10 **NIGHTSHOT/NIGHTFRAMING switch** (55)
- 11 **Speaker**
- 12 **Hot shoe** (63, 111)
- 13 **AE LOCK button** (52)
- 14  (metering mode) button (51)
- 15 **WHT BAL (white balance) button** (54)
- 16  (one-push white balance) button (54)
- 17 **ZOOM button** (23)
- 18 **FOCUS (AUTO/ZOOM / MANUAL) switch** (23, 48)

## 1 Mode dial

 : To shoot still images in auto adjustment mode

 P: To shoot still images in programmed mode

**S**: To shoot in the shutter speed priority mode

**A**: To shoot in the aperture priority mode

**M**: To shoot in the manual exposure mode

**SCN**: To shoot in the Scene Selection mode









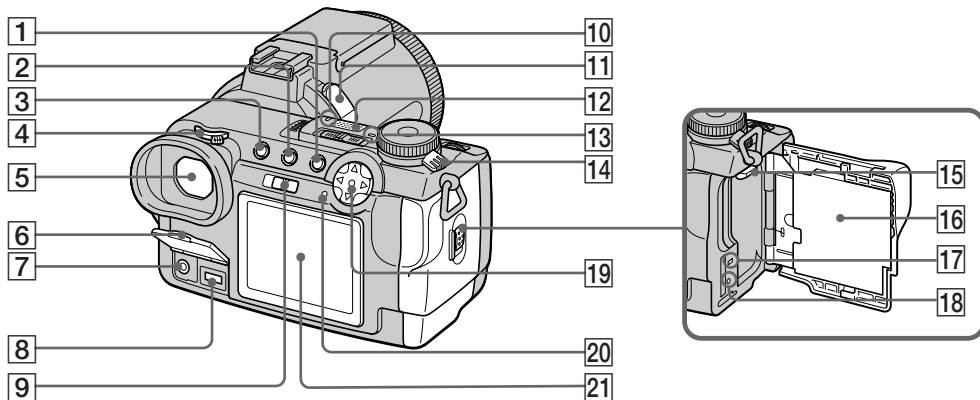

**SET UP**: To set the SET UP items

 : To shoot movies, Clip Motion images or Multi Burst mode images

 : To view or edit images





- |                                                                                                                |                                                                                                                                                                                                                                                                                                                                                                                                                                                                                  |
|----------------------------------------------------------------------------------------------------------------|----------------------------------------------------------------------------------------------------------------------------------------------------------------------------------------------------------------------------------------------------------------------------------------------------------------------------------------------------------------------------------------------------------------------------------------------------------------------------------|
| <b>1</b> MENU button (19)                                                                                      | <b>16</b> Battery/"Memory Stick" cover (18)                                                                                                                                                                                                                                                                                                                                                                                                                                      |
| <b>2</b>  (index) button (34) | <b>17</b> Access lamp (18)                                                                                                                                                                                                                                                                                                                                                                                                                                                       |
| <b>3</b> DISPLAY button (22)                                                                                   | <b>18</b> RESET button (92)                                                                                                                                                                                                                                                                                                                                                                                                                                                      |
| <b>4</b> Finder adjustment dial (22)                                                                           | <b>19</b> Control button<br>(Menu on) (  ,  ,  ,  ,  ) (15) |
| <b>5</b> Finder (22)                                                                                           | (Menu off) (  ,  ,  ,  ) (21, 24, 26)                                                                                                        |
| <b>6</b> Jack cover (11)                                                                                       | <b>20</b>  /CHG (charge) lamp (12)                                                                                                                                                                                                                                                                                                                                                              |
| <b>7</b> A/V OUT (MONO) jack (35)                                                                              | <b>21</b> LCD screen                                                                                                                                                                                                                                                                                                                                                                                                                                                             |
| <b>8</b> DC IN jack (11, 14)                                                                                   |                                                                                                                                                                                                                                                                                                                                                                                                                                                                                  |
| <b>9</b> FINDER/LCD switch (22)                                                                                |                                                                                                                                                                                                                                                                                                                                                                                                                                                                                  |
| <b>10</b> Self-timer lamp (25)                                                                                 |                                                                                                                                                                                                                                                                                                                                                                                                                                                                                  |
| <b>11</b> ACC (accessory) jack                                                                                 |                                                                                                                                                                                                                                                                                                                                                                                                                                                                                  |
| <b>12</b> Built-in microphone                                                                                  |                                                                                                                                                                                                                                                                                                                                                                                                                                                                                  |
| <b>13</b> POWER lamp (15)                                                                                      |                                                                                                                                                                                                                                                                                                                                                                                                                                                                                  |
| <b>14</b> POWER switch (15)                                                                                    |                                                                                                                                                                                                                                                                                                                                                                                                                                                                                  |
| <b>15</b> Battery eject lever (12)                                                                             |                                                                                                                                                                                                                                                                                                                                                                                                                                                                                  |

- Audio output is monaural.
- Do not touch the built-in microphone while recording.
- Use ACC jack to connect an external flash or the remote control tripod.

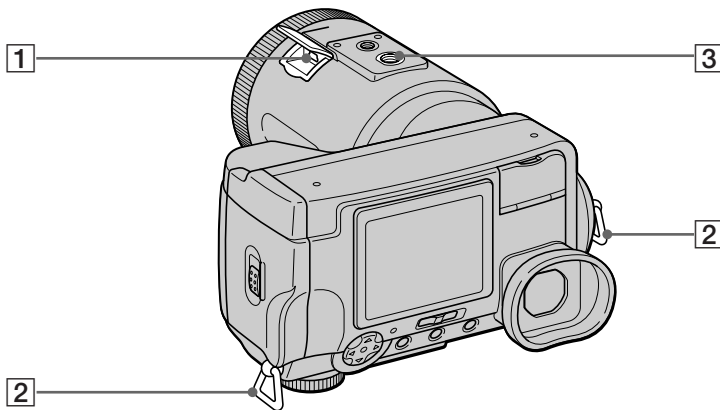

- 1 **ψ (USB) jack (84)**
- 2 **Hook for shoulder strap**
- 3 **Tripod receptacle**

- Use a tripod with a screw length of less than 5.5 mm (7/32 inch). You will be unable to firmly secure the camera to tripods having longer screws, and may damage the camera.

**Attaching the lens cap and the shoulder strap.**

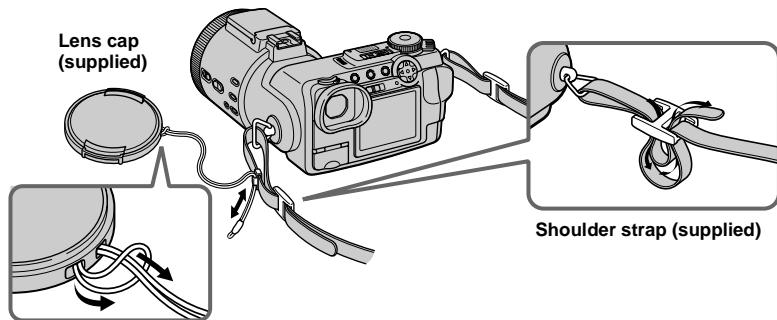

## Charging the battery pack

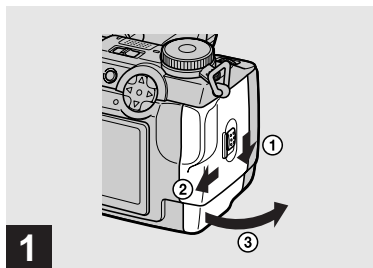

- 1** → Open the battery/“Memory Stick” cover.

Slide the cover in the direction of the arrow.

- Be sure to turn off your camera when charging the battery pack (page 15).
- Your camera operates only with the “InfoLITHIUM” NP-FM50 battery pack (M series) (supplied) (page 115).

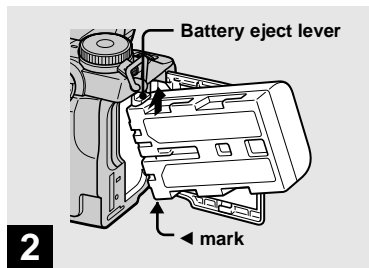

- 2** → Install the battery pack, then close the battery/“Memory Stick” cover.

Insert the battery pack with the ◀ mark facing toward the battery compartment as illustrated.

Make sure the battery pack is firmly inserted all the way, then close the cover.

- The battery pack is easily inserted by pushing the battery eject lever at the front of the battery compartment up.

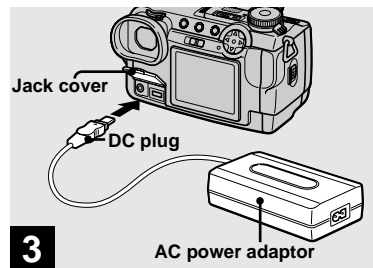

- 3** → Open the jack cover and connect the AC-L10A/L10B AC power adaptor (supplied) to the DC IN jack of your camera.

Connect the plug with the ▲ mark facing up.

- Do not short the DC plug of the AC power adaptor with a metallic object, as this may cause malfunction.

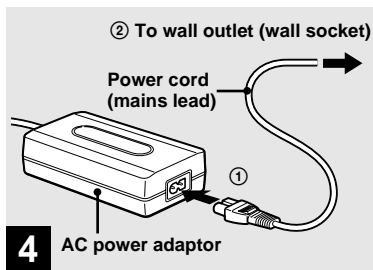

➔ **Connect the power cord (mains lead) to the AC power adaptor and then to a wall outlet (wall socket).**

The ⚡/CHG lamp (orange) lights up when charging begins, and goes off when charging is completed.

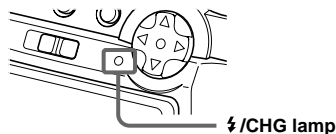

- After charging the battery pack, disconnect the AC power adaptor from the DC IN jack of your camera.

## To remove the battery pack

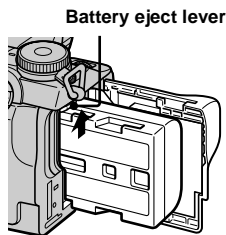

Open the battery/“Memory Stick” cover. Slide the battery eject lever in the direction of the arrow, and remove the battery pack.

- Be careful not to drop the battery pack when removing it.

## Battery remaining indicator

The battery remaining indicator on the screen shows the remaining shooting or viewing time.

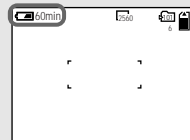

- The displayed remaining time may not be correct under certain circumstances or conditions.
- When you switch the FINDER/LCD switch, it takes about one minute for the correct battery remaining time to appear.

## Charging time

Approximate time to charge a completely discharged battery pack using the AC-L10A/L10B AC power adaptor at a temperature of 25°C (77°F).

Battery pack	Charging time (min.)
NP-FM50 (supplied)	Approx. 150

## Number of images and battery life that can be recorded/ viewed

The tables show the approximate number of images and the battery life that can be recorded/ viewed when you shoot images in normal mode with a fully charged battery pack at a temperature of 25°C (77°F). The numbers of images that can be recorded or viewed take into account changing the supplied “Memory Stick” as necessary. Note that the actual numbers may be less than indicated depending on the conditions of use.

### Shooting still images Normal shooting mode\*1)

Image size	NP-FM50 (supplied)	
	No. of images	Battery life (min.)
2560×1920	Approx. 410	Approx. 205

\*1) Shooting in the following situations:

- [P. QUALITY] is set to [FINE]
- Shooting one time every 30 seconds
- The zoom is switched alternately between the W and T ends
- The flash strobes once every two times
- The power turns on and off once every ten times.

### Viewing still images\*2)

Image size	NP-FM50 (supplied)	
	No. of images	Battery life (min.)
2560×1920	Approx. 7000	Approx. 350
640×480	Approx. 7000	Approx. 350

\*2) Viewing single images in order at about three second intervals

### Shooting movies\*3)

	NP-FM50 (supplied)
Continuous shooting	Approx. 230 min.

\*3) Shooting continuously at 160×112 image size

- The remaining indicator will decrease in the following situations:
  - The surrounding temperature is low
  - The flash is used
  - The camera has been turned ON and OFF many times
  - [LCD BACKLIGHT] or [EVF BACKLIGHT] is set to [BRIGHT] in the SET UP settings
  - The battery power is low
    - The battery capacity decreases as you use it more and more and as time passes (page 116).
- The number of images is the same whether you use the finder or the LCD screen for shooting/ viewing images.

## Using an external power source

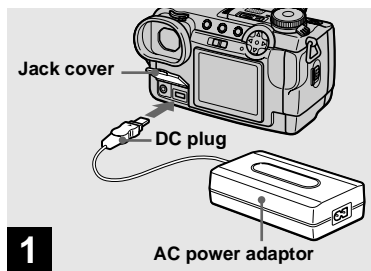

- Open the jack cover and connect the AC-L10A/L10B AC power adaptor (supplied) to the DC IN jack of your camera.

Connect the plug with the ▲ mark facing up.

- Connect the AC power adaptor to an easily accessible wall outlet (wall socket) close by. If any trouble occurs while using the adaptor, immediately shut off the power by disconnecting the plug from the wall outlet (wall socket).
- Remove the battery pack when using an external power source.

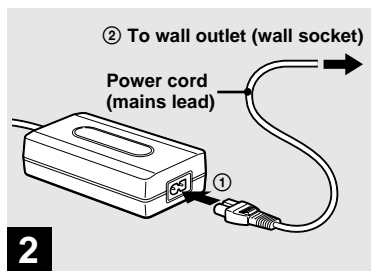

- Connect the power cord (mains lead) to the AC power adaptor and then to a wall outlet (wall socket).

- When you have finished using the AC power adaptor, disconnect it from the DC IN jack of the camera.
- The set is not disconnected from the AC power source (mains) as long as it is connected to the wall outlet (wall socket), even if the unit itself has been turned off.
- To use power from an automobile, use the Sony Car Battery Adapter (not supplied).
- If you insert or remove the DC plug while you are using the battery, the power may shut off.

## Using your camera abroad

### Power sources

You can use your camera in any country or area with the supplied AC power adaptor within 100 V to 240 V AC, 50/60 Hz. Use a commercially available AC plug adaptor [a], if necessary, depending on the design of the wall outlet (wall socket) [b].

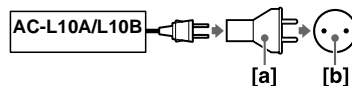

- Do not use an electronic transformer (travel converter), as this may cause a malfunction.

## Turning on/off your camera

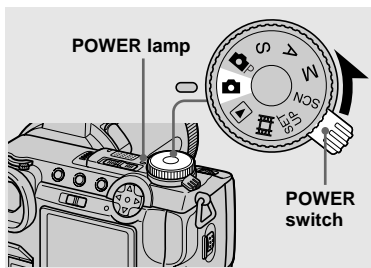

→ Slide the **POWER switch** in the direction of the arrow.

The **POWER lamp** (green) lights up and the power is on. When you turn on your camera for the first time, the **CLOCK SET** screen appears (page 16).

### Turning off the power

Slide the **POWER switch** in the direction of the arrow again. The **POWER lamp** goes out, and the camera turns off.

## Auto power-off function





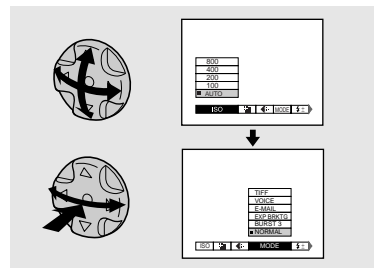

If you do not operate the camera for about three minutes during shooting or viewing or when performing **SET UP**, the camera turns off automatically to prevent wearing down the battery. The auto power-off function only operates when the camera is operating using a battery pack. The auto power-off function also will not operate in the following circumstances.

- When viewing movies
- When playing back a slide show
- When a connector is plugged into the  (USB) jack or the A/V OUT (MONO) jack.

## How to use the control button





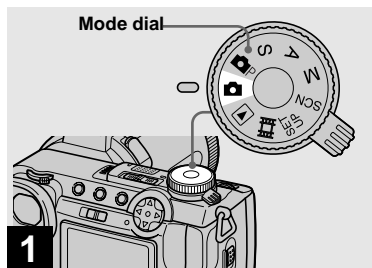

To change the current settings of the camera, bring up the menu or the **SET UP** screen (page 42), and use the control button to make the changes.

For each item, press /// to select the desired value, then press the center  or / to make the setting.

## Setting the date and time



➔ Set the mode dial to .

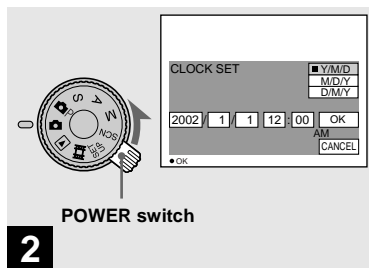

- You can also carry out this operation when the mode dial is set to , S, A, M, SCN,  or .
- To change the date and time, set the mode dial to SET UP, select [CLOCK SET] in  (SETUP 2) (page 112), and perform the procedure from step **3**.

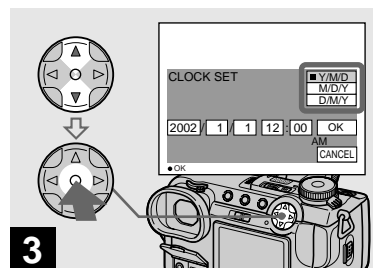

➔ Slide the POWER switch in the direction of the arrow to turn on the power.

The POWER lamp (green) lights up and the CLOCK SET screen appears on the screen.



➔ Select the desired date display format with / on the control button, then press .

Select from [Y/M/D] (year/month/day), [M/D/Y] (month/day/year) or [D/M/Y] (day/month/year).

- If the rechargeable button battery, which provides the power for saving the time data, is ever fully discharged (page 113), the CLOCK SET screen will appear again. When this happens, reset the date and time, by starting from step **3** above.



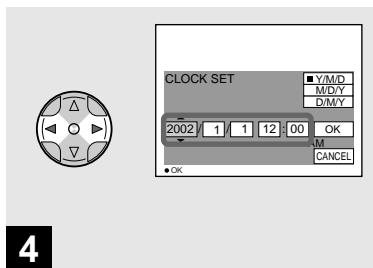

- 4** → Select the year, month, day, hour or minute item you want to set with ◀/▶ on the control button.

The item to be set is indicated with ▲/▼.

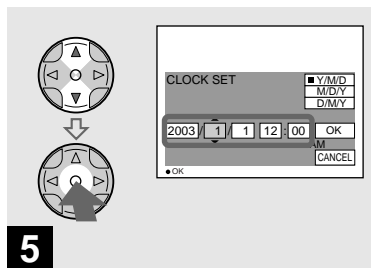

- 5** → Set the numeric value with ▲/▼ on the control button, then press ● to enter it.

After entering the number, ▲/▼ moves to the next item. Repeat this step until all of the items are set.

- If you selected [D/M/Y] in step **3**, set the time on a 24-hour cycle.

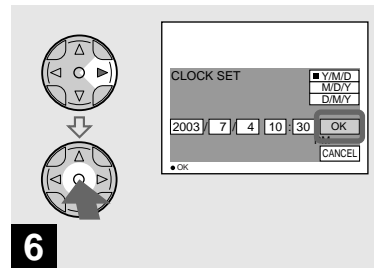

- 6** → Select [OK] with ▶ on the control button, then press ●.

The date and time are entered and the clock starts to keep time.

- To cancel the date and time setting, select [CANCEL] with ▲/▼/◀/▶ on the control button, then press ●.

## Inserting and removing a "Memory Stick"

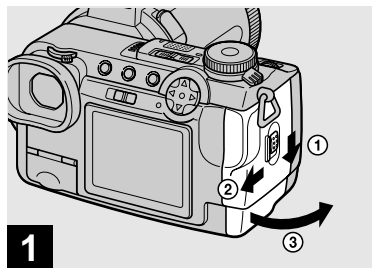

### ➔ Open the battery/"Memory Stick" cover.

Slide the cover in the direction of the arrow.

- For details on "Memory Stick," see page 114.

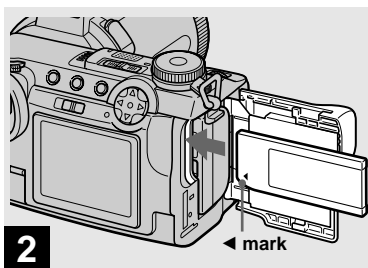

### ➔ Insert the "Memory Stick."

Insert a "Memory Stick" as far as it can go with the ◀ mark facing as illustrated.

- Push the "Memory Stick" all of the way in so that it is securely seated in the connector. If the "Memory Stick" is not inserted correctly, you may not be able to record or display images with the "Memory Stick."

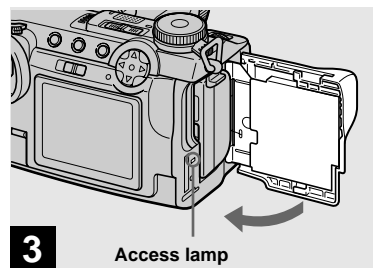

### ➔ Close the battery/"Memory Stick" cover.

**To remove a "Memory Stick"**

Open the battery/"Memory Stick" cover, then push the "Memory Stick" to pop it out.

- **Whenever the access lamp is lit, the camera is recording or reading an image. Never remove the "Memory Stick" or turn off the power at this time.**

## Setting the still image size

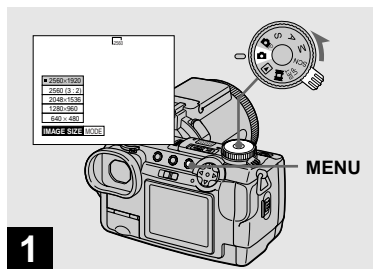

1



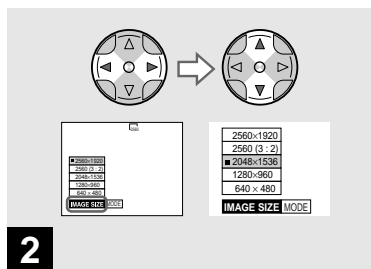

➔ Set the mode dial to  and turn on the power, then press MENU.

The menu appears.

- You can also carry out this operation when the mode dial is set to , S, A, M or SCN.
- For details on the image quality, see page 32.



2

➔ Select  (IMAGE SIZE) with  on the control button, then select the desired image size with / .

The image size is set.

When the setting is complete, press MENU so that the menu disappears from the screen.



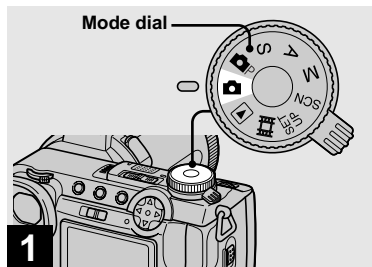

- The image size selected here is maintained even when the power is turned off.

## Basic still image shooting (using auto adjustment mode)



➔ Set the mode dial to , and turn on the power.

Remove the lens cap.

- When the mode dial is set to , the focus, exposure and white balance are adjusted automatically to allow easy shooting.
- You can also carry out this operation when the mode dial is set to P. When the mode dial is set to  or P, the shutter speed is automatically adjusted between 1/2000 and 1/30 second.
- This camera can create new folders and select folders to be stored in the “Memory Stick” (page 64).
- Still images are recorded in JPEG format.

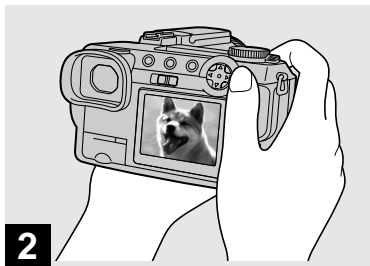

➔ Hold the camera steadily with both hands and position the subject in the center of the focus frame.

Do not cover the lens or flash with your fingers.

- The picture quality is set to [FINE].
- The frame appearing on the screen shows the focus adjustment range.

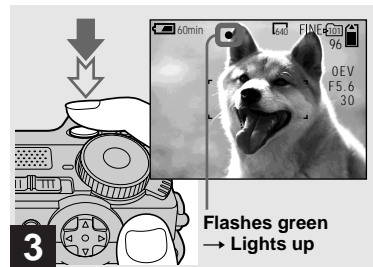

➔ Press and hold the shutter button halfway down.

The beep sounds but the image is not yet recorded. When the AE/AF lock indicator changes from flashing to steadily lit, the camera is ready for shooting.

The flash automatically pops up and strobes when the surroundings are dark.

- If you release the shutter button, the recording will be canceled.
- The minimum focal distance to the subject is approximately more than 50 cm (19 3/4 inches) at the W side or 90 cm (35 1/2 inches) at the T side. To shoot even closer subjects, use macro recording mode (page 24).

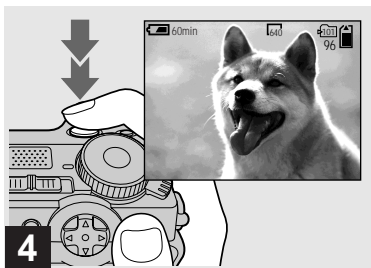

#### ➔ Press the shutter button fully down.

The shutter sounds. The image will be recorded in the “Memory Stick”.

- When operating the camera using a battery pack, if you do not operate the camera for about three minutes during recording or playback, the camera turns off automatically to prevent wearing down the battery (page 15).

## Auto Focus

When you try to shoot a subject that is difficult to focus on, the AE/AF lock indicator changes to flashing slowly. The Auto Focus function may have difficulty working under the following conditions. In such cases, release the shutter button, then recompose the shot and focus again.

- The subject is distant from the camera and dark.
- The contrast between the subject and its background is poor.
- The subject is seen through glass, such as a window.
- A fast-moving subject.
- The subject reflects or has a lustrous finish, such as a mirror or a luminous body.
- A flashing subject.

## Checking the last image you shot — Quick Review



#### ➔ Press ◀ (Ⓢ) on the control button.

To return to the normal shooting mode, press lightly on the shutter button or press ◀ (Ⓢ) again.

#### To delete the image displayed on the screen

- 1 Press MENU to display the menu.
- 2 Select [DELETE] with ▶ on the control button, then press ●.
- 3 Select [OK] with ▲ on the control button, then press ●.  
The image is deleted.

## Shooting images with the finder

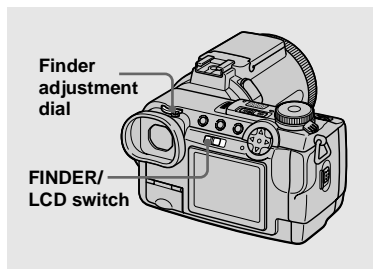

With the FINDER/LCD switch, you can choose to shoot either using the finder or the LCD screen. When you use the finder, the image does not appear on the LCD screen. Turn the finder adjustment dial until the image appears clearly within the finder, then shoot the image.

- For a detailed description of the indicators, see page 118.

## Indicators on the screen during shooting

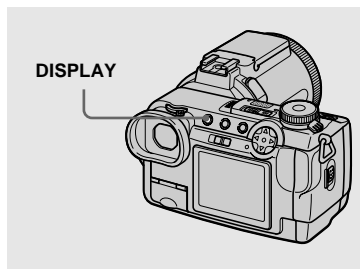

Each time you press DISPLAY, the display changes in the following order.

- For a detailed description of the indicators, see page 118.
- Indicators on the screen are not recorded.

### Indicators on



Histogram on (A histogram of the image is displayed in the lower left corner of the screen (page 50).)



Indicators off (Only warning messages and manual adjustment items which are set using the jog dial are on.)



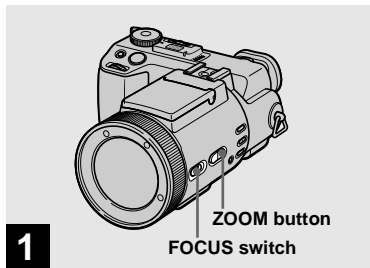

→ Set the FOCUS switch to AUTO/ZOOM.

- The factory setting is AUTO/ZOOM.
- The ZOOM button can also be used. The zoom operates slowly when the button is pressed lightly, and quickly when the button is pressed deeply.
- Zoom does not work when [CONVERSION LENS] is set to [ON] in the SET UP settings (page 110).

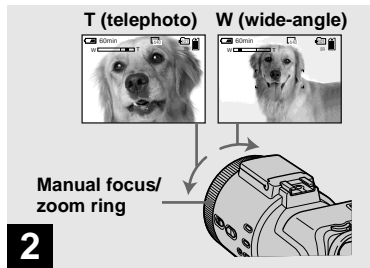

→ Turn the manual focus/zoom ring to choose the desired image size for shooting.

### Minimum focal distance to the subject

**When the zoom is set all the way to the W side:**

Approx. 50 cm (19 3/4 inches) from the lens surface

**When the zoom is set all the way to the T side:**

Approx. 90 cm (35 1/2 inches) from the lens surface

- The manual focus/zoom ring directions noted above are the factory settings. The ring directions can be changed by [ZOOM RING SETUP] in the SET UP settings (page 111).

### Digital zoom

When zoom exceeds 5×, the image is enlarged by digital processing. The maximum digital zoom magnification is 10×. Digital zooming causes the image quality to deteriorate, so when digital zoom is not necessary, set [DIGITAL ZOOM] to [OFF] in the SET UP settings (page 110).

The T side of the bar shows the digital zoom zone.

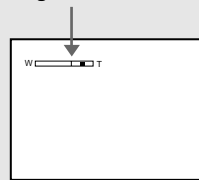

- During digital zoom, the AF frame does not appear on the screen.
- Digital zoom does not work for movies.

## Changing the lens orientation

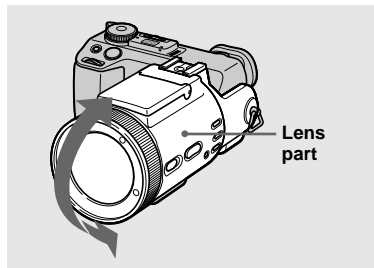

You can adjust the angle by turning the lens part upward up to 77 degrees and downward up to 36 degrees.

## Shooting close-ups — Macro

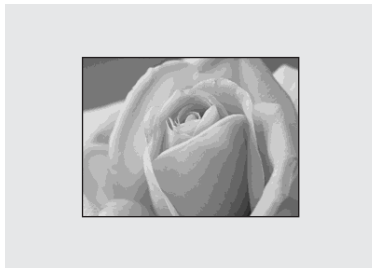

The macro recording mode is used when zooming up a small subject, such as flowers or insects. You can shoot close-ups of subjects up to the distances specified below.



### When the zoom is set all the way to the W side:

Approx. 2 cm (13/16 inches) from the lens surface

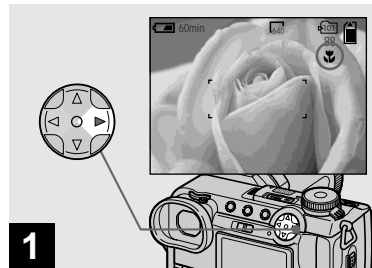

### When the zoom is set all the way to the T side:

Approx. 90 cm (35 1/2 inches) from the lens surface



➔ **Set the mode dial to , and press  on the control button.**

The  (macro) indicator appears on the screen.

- If the menu is currently displayed, press MENU first so that the menu disappears.
- You can also carry out this operation when the mode dial is set to , S, A, M, SCN (other than landscape mode, page 29) or .



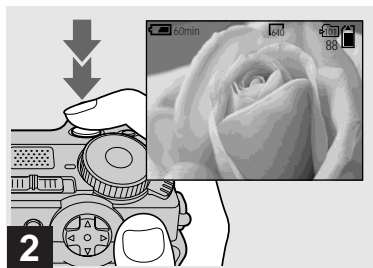

➔ **Center the subject in the frame, and shoot the image.**

### To return to normal recording mode

Press **▶** (📷) on the control button again.  
The 📷 indicator disappears.

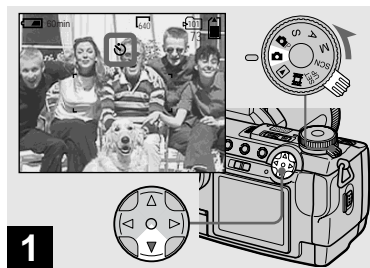

➔ **Turn the mode dial to 📷, and press ▼ (📷) on the control button.**

The 📷 (self-timer) indicator appears on the screen.

- If the menu is currently displayed, press MENU first so that the menu disappears.
- You can also carry out this operation when the mode dial is set to 📷P, S, A, M, SCN or 📷.

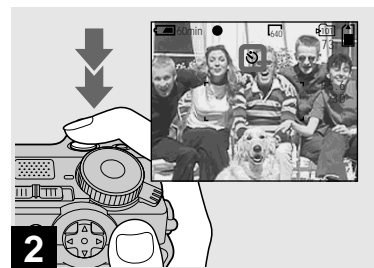

➔ **Center the subject in the frame, and press the shutter button fully down.**

The self-timer lamp (page 9) flashes and a beep sounds after you press the shutter button until the shutter is released (approximately 10 seconds).



### To cancel the self-timer in the middle of the operation

Press ▼ (📷) on the control button again.

- If you press the shutter button while standing in front of the camera, the focus and the exposure may not be correctly set.

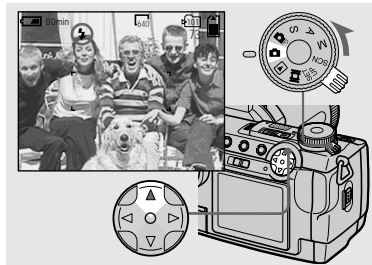
## Selecting a flash mode



➔ Set the mode dial to , and press  on the control button repeatedly to select a flash mode.

Each time you press , the indicator changes as follows.







**No indicator (Auto):** The flash automatically pops up and strobes when the surroundings are dark (default).



** (Forced flash):** The flash strobes regardless of the surrounding brightness.



** (No flash):** The flash does not strobe.

- If the menu is currently displayed, press MENU first so that the menu disappears.
- You can also carry out this operation when the mode dial is set to , S, A, M, SCN or  (Clip Motion).
- You can change the brightness of the flash with [FLASH LEVEL] in the menu settings (page 107). (You cannot change the brightness of the flash while the mode dial is set to .)
- When [ISO] is set to [AUTO] in the menu settings, the recommended shooting distance using the built-in flash is approximately 0.3 m to 4.5 m (11 7/8 inches to 177 1/4 inches). When it is not set to [AUTO], the flash may be ineffective even if the flash level is changed.
- When using the Auto or  (Forced flash) mode, you may notice some noise in the image when you look at the screen in a dark place, but this will have no effect on the shot image.
- While charging the flash, the /CHG lamp flashes. After the charging is complete, the lamp goes out.
- When you press the shutter button halfway down while the flash is strobing, the /CHG lamp turns on.
- You can mount an external flash on this camera (page 63).
- Attaching a conversion lens (not supplied) may block the light from the built-in flash or cause the lens shadow to appear.

## To reduce the red-eye phenomenon when shooting live subjects

Set [RED EYE REDUCTION] to [ON] in the SET UP settings (page 110).  indicator appears on the screen, and the flash pre-strobes before shooting to reduce the red-eye phenomenon.



- Red-eye reduction may not produce the desired effects depending on individual differences, the distance to the subject, if the subject does not see the pre-strobe, or other conditions.

## Recording images with the hologram AF

The hologram AF is fill light to focus more easily on a subject in dark surroundings. Set [HOLOGRAM AF] (page 110) to [AUTO] in the SET UP settings. The factory setting is [AUTO]. **CON** appears on the screen and the hologram AF emits light when the shutter button is pressed halfway until the focus is locked.



- If hologram AF light does not reach the subject sufficiently or the subject has no contrast, focus will not be achieved. (A distance up to approximately 4.5 m (177 1/4 inches) is recommended.)
- Focus is achieved as long as hologram AF light reaches the subject, even if the light is slightly off the center of the subject.
- The hologram AF will not emit light when adjusting the focus manually.
- The hologram AF will not emit light when [CONVERSION LENS] is set to [ON] in the SET UP settings (page 110).
- If the hologram AF emitter is dirty, the hologram AF light may be dimmed and focus may not be achieved. In this case, wipe the hologram AF emitter with a dry cloth.
- The hologram AF emitter emits very bright light. Although there are no problems with safety, directly looking into the hologram AF emitter at close range is not recommended, as you may see residual spots for several minutes afterwards, such as after looking into a flashlight.
- Do not block the hologram AF emitter during recording.
- Attaching an optional filter, wide conversion lens or telephoto conversion lens may interfere with Holographic AF light emission.

## About Hologram AF

“Hologram AF (Auto-Focus)” is an AF optical system that applies laser holograms to enable you to shoot still images in dark places. The Hologram AF system uses gentler radiation than conventional high-brightness LEDs or lamps, thus satisfying Laser Class 1\* specifications and maintaining higher safety for human eyes.

\* Hologram AF satisfies Class 1 (time base 30 000 seconds), specified in JIS (Japan), IEC (EU), and FDA (US) industry standards. Complying with these standards identifies the laser product as safe, under the condition that a human can look at the laser light either directly or through a lens for 30 000 seconds.

## Inserting the date and time on a still image

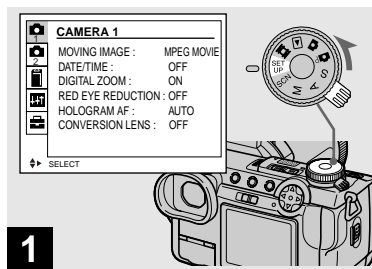

➔ Set the mode dial to SET UP.

The SET UP screen appears.

- When images are shot with the date and time superimposed, the date and time cannot be removed later.
- The date and time do not appear on the screen during shooting, instead, "DATE" appears in the upper left corner of the screen. The actual date and time appear during playback only.

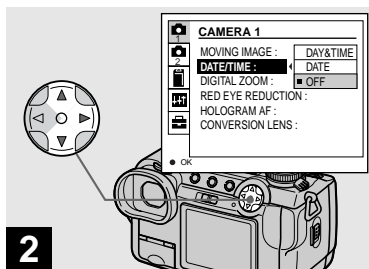

➔ Select **1** (CAMERA 1) with ▲ on the control button, then press ►. Select [DATE/TIME] with ▲/▼, then press ►.

- If you select [DATE], the date is superimposed onto the image in the order selected in "Setting the date and time" (page 16).

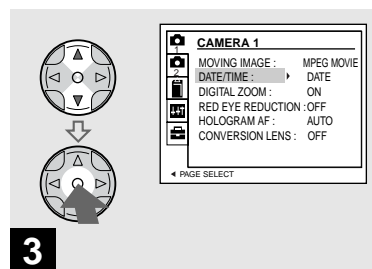

➔ Select the date and time setting with ▲/▼ on the control button, then press ●.

**DAY & TIME:** Superimposes the date, hour, and minute onto the image.

**DATE:** Superimposes the year, month and day onto the image.

**OFF:** Does not superimpose the date and time onto the image.

After the setting has been completed, set the mode dial to **1**, and shoot the image.

- You can also shoot images with the mode dial set to **P**, **S**, **A**, **M** or **SCN**.
- This setting is maintained even when the power is turned off.

### Twilight mode



When shooting night scenes, people at night, landscapes or portraits, use the modes listed below to improve the quality of your images.

### Twilight mode

Allows you to shoot night scenes without losing the dark atmosphere of the surroundings. The shutter speed becomes slower, so we recommend that you use a tripod to prevent shaking.

- The flash cannot be used in this mode.
- The hologram AF does not emit.

### Twilight portrait mode



### Twilight portrait mode

Suitable for shooting portraits in dark places. The shutter speed becomes slower, so we recommend that you use a tripod to prevent shaking.

- Allows you to shoot sharp images of people in dark places without losing the dark atmosphere of the surroundings.
- The flash strobes regardless of the surrounding brightness.

### Landscape mode

Focuses only on a distant subject to shoot landscapes, etc.

- You cannot shoot in macro mode.
- The flash does not strobe automatically.
- The hologram AF does not emit.

### Landscape mode

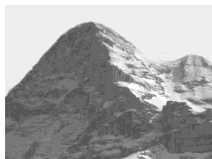

### Portrait mode



### Portrait mode

Suitable for shooting portraits. Backgrounds blur away, and the subject is sharpened.

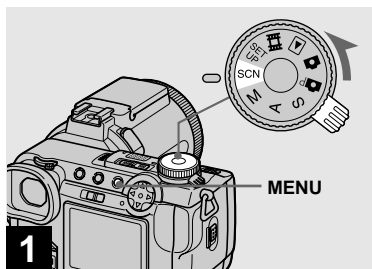

→ Set the mode dial to SCN, then press MENU.

The menu appears.

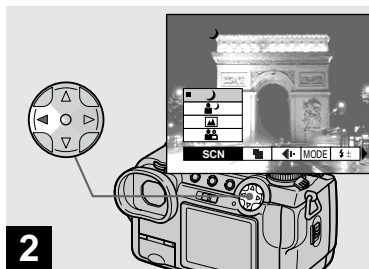

→ Select [SCN] with ◀ on the control button.

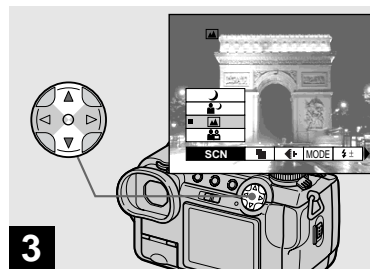

→ Select the desired mode with ▲/▼ on the control button.

The mode is set.

When the setting is complete, press MENU so that the menu disappears from the screen.

#### To cancel Scene Selection

Set the mode dial to a different mode.

- This setting is maintained even when the power is turned off.

## Setting the still image quality

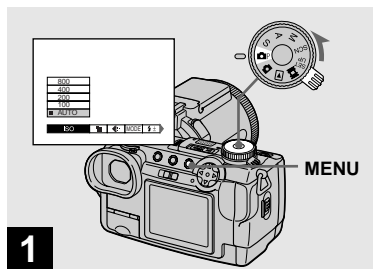

1

→ Set the mode dial to **P** and turn on the power, then press **MENU**.

The menu appears.

- You can also carry out this operation when the mode dial is set to S, A, M or SCN.

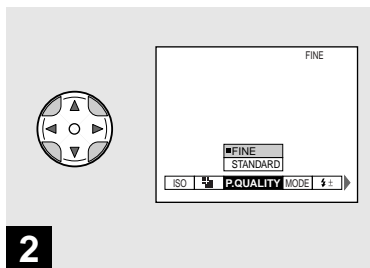

2

→ Select **P.QUALITY** with **◀/▶** on the control button, then select the desired image quality with **▲/▼**.

The image quality is set.

When the setting is complete, press **MENU** so that the menu disappears from the screen.

- You can select the image quality from either [FINE] or [STANDARD].
- The image quality value selected here is maintained even when the power is turned off.

## Image size and quality

You can choose image size (number of pixels) and image quality (compression ratio) based on the kind of images you want to shoot. The larger you make the image size and the higher you make the image quality, the better your image, but also the larger the amount of data needed to preserve your image. This means you can save fewer images in your “Memory Stick.”

Choose an image size and quality level appropriate for the kind of images you want to shoot.

You can resize the images later (Resize function, page 72).

You can choose image size from among the five options in the following tables. The below image size is a minimum setting for examples. When you want to improve image quality, select the larger image size.

Image size	Examples
2560×1920	Very fine prints
2560 (3:2)	3:2 prints*
2048×1536	Printing A4 size images
1280×960	Printing postcard size images
640×480	Creating home pages

\* This option records images in a horizontal to vertical proportion of 3:2 to match the size of the print paper used.

## The number of images\*\* that can be saved in a “Memory Stick”

The number of images that can be saved in FINE (STANDARD) mode are shown below. (Units: number of images)

Capacity Image size	16MB	32MB	64MB	128MB	MSX-256	MSX-512	MSX-1G
2560×1920	6 (11)	12 (23)	25 (48)	51 (96)	92 (174)	188 (354)	384 (723)
2560 (3:2)	6 (11)	12 (23)	25 (48)	51 (96)	92 (174)	188 (354)	384 (723)
2048×1536	10 (18)	20 (37)	41 (74)	82 (149)	148 (264)	302 (537)	617 (1097)
1280×960	24 (46)	50 (93)	101 (187)	202 (376)	357 (649)	726 (1320)	1482 (2694)
640×480	97 (243)	196 (491)	394 (985)	790 (1975)	1428 (3571)	2904 (7261)	5928 (14821)

\*\* When [REC MODE] is set to [NORMAL]  
For the number of images that can be saved in other modes, see page 104.

- When the images are viewed on the screen of the camera, they all look the same size.
- Number of images that can be saved can differ from these values according to shooting conditions.
- When the number of remaining shooting images is greater than 9999, the >9999 indicator appears on the LCD screen.



# Viewing images on the screen of your camera

## Single (single-image) screen

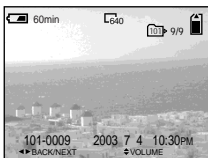

You can view images shot with your camera almost immediately on the screen. You can select the following three methods for viewing images.

### Single (single-image) screen

You can view one image at a time, displayed over the entire screen.

### Index (nine-image) screen

Nine images are displayed simultaneously in separate panels on the screen.

## Index (nine-image) screen



## Index (triple-image) screen

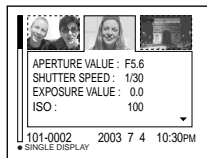



### Index (triple-image) screen

Three images are displayed simultaneously in separate panels on the screen. Various image information items are also displayed.

- For a detailed description of the screen indicators, see page 120.
- For details on movies, see page 76.

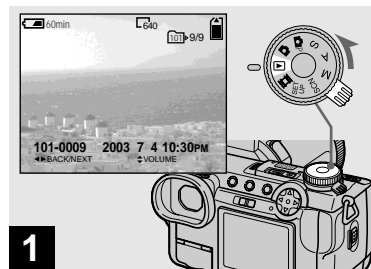
# Viewing single images



➔ Set the mode dial to , and turn on the power.

The last image in the selected recording folder (page 66) appears on the screen.

## Viewing an index screen (nine-image or triple-image)

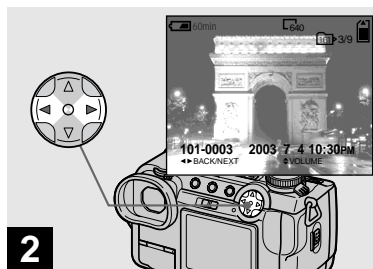

→ Select the desired still image with ◀/▶ on the control button.

- ◀ : To display the preceding image
- ▶ : To display the next image

- You can easily view the next/previous image by turning the jog dial.

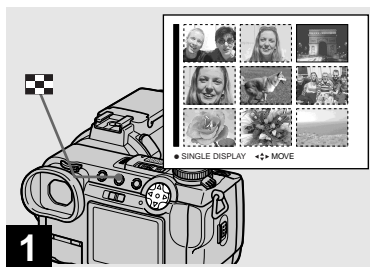

→ Press  once.

The display switches to the **Index (nine-image) screen**.

**To display the next (previous) index screen**

Press ▲/▼/◀/▶ on the control button to move the yellow frame up/down/left/right.

- You can view the next/previous screen by turning the jog dial.

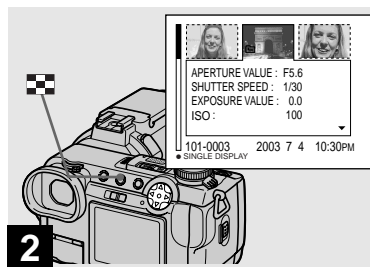

→ Press .

The display switches to the **Index (triple-image) screen**.

Press ▲/▼ on the control button to display the remaining image information.

**To display the next (previous) index screen**

Press ◀/▶ on the control button.

**To return to the single-image screen**

Press  repeatedly, or press ● on the control button.

## Viewing images on a TV screen

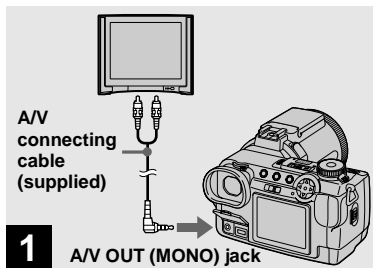

- ➔ Connect the A/V connecting cable to the A/V OUT (MONO) jack of the camera and the audio/video input jacks of the TV.

If your TV has stereo input jacks, connect the audio plug (black) of the A/V connecting cable to the left audio jack.

- Turn off both your camera and the TV before connecting the camera and the TV with the A/V connecting cable.

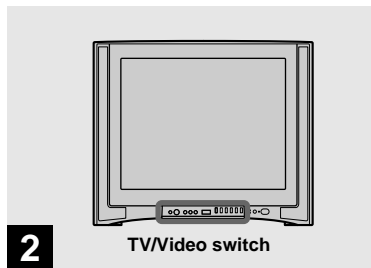

- ➔ Turn on the TV and set the TV/Video switch to “Video”.

- The name and location of this switch may differ depending on your TV.

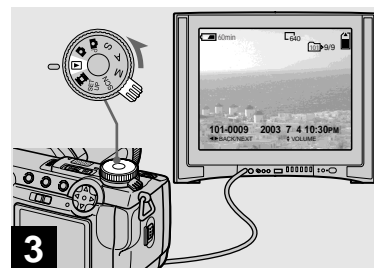

- ➔ Set the mode dial to , and turn on the camera.

Press  on the control button to select the desired image.

- When using your camera abroad, it may be necessary to set [VIDEO OUT] in SET UP setting to match that of your TV system (page 112).

### **Viewing images on a TV screen**

If you want to view images on a TV screen, you need a TV with a video input jack and a A/V connecting cable (supplied).

The color system of the TV must match that of your digital still camera. Check the following lists:

#### **NTSC system**

Bahama Islands, Bolivia, Canada, Central America, Chile, Colombia, Ecuador, Jamaica, Japan, Korea, Mexico, Peru, Surinam, Taiwan, the Philippines, the U.S.A., Venezuela, etc.

#### **PAL system**

Australia, Austria, Belgium, China, Czech Republic, Denmark, Finland, Germany, Holland, Hong Kong, Italy, Kuwait, Malaysia, New Zealand, Norway, Portugal, Singapore, Slovak Republic, Spain, Sweden, Switzerland, Thailand, United Kingdom, etc.

#### **PAL-M system**

Brazil

#### **PAL-N system**



Argentina, Paraguay, Uruguay

#### **SECAM system**

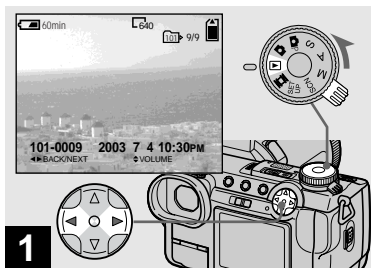

Bulgaria, France, Guiana, Hungary, Iran, Iraq, Monaco, Poland, Russia, Ukraine, etc.

## Deleting images



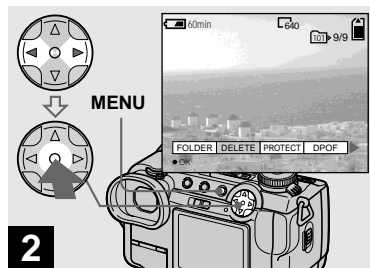

- 1** → Set the mode dial to , and turn on the camera. Press  on the control button to select the image you want to delete.



- 2** → Press MENU and select [DELETE] with  on the control button, then press .

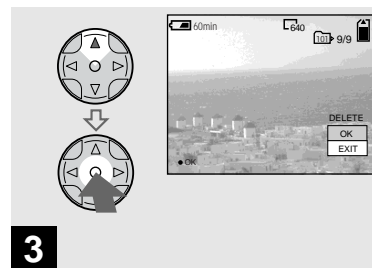



The image has not yet been deleted at this point.





- 3** → Select [OK] with  on the control button, then press .

“MEMORY STICK ACCESS” appears on the screen. When this message disappears, the image has been deleted.

### To continue and delete other images

Display the image to be deleted with  on the control button, select [DELETE] and press . Then, select [OK] with  and press .

### To cancel deleting

Select [EXIT] with  on the control button, then press .

## Deleting images in index (nine-image) mode

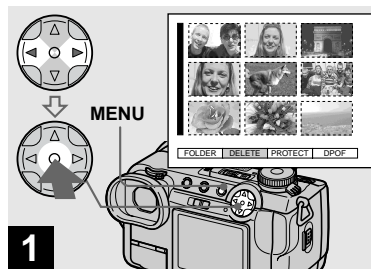

- While an index (nine-image) screen (page 34) is displayed, press MENU and select [DELETE] with ◀/▶ on the control button, then press ●.

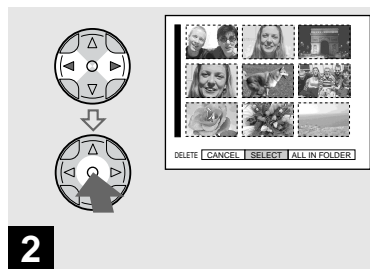

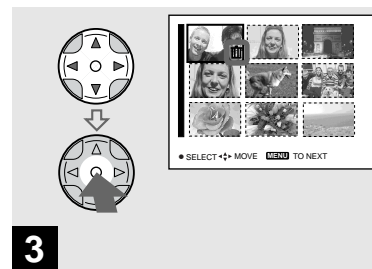

- Select [SELECT] with ◀/▶ on the control button, then press ●.

**To delete all the images in the folder**  
Select [ALL IN FOLDER] with ▶ on the control button, then press ●. Select [OK], then press ●. To cancel deleting, select [EXIT], then press ●.



- Select an image you want to delete with ▲/▼/◀/▶ on the control button, then press ●.

The green  indicator appears on the selected image. At this point, the image has not yet been deleted. Repeat this step for all of the images you want to delete.

- To cancel a selection, press ● again so that the  indicator disappears.

## Deleting images in index (triple-image) mode

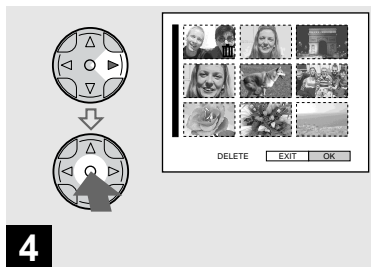

- 4** → Press **MENU** and select **[OK]** with **▶** on the control button, then press **●**.

“MEMORY STICK ACCESS” appears on the screen. When this message disappears, the images have been deleted.

### To cancel deleting

Select **[EXIT]** with **◀** on the control button, then press **●**.

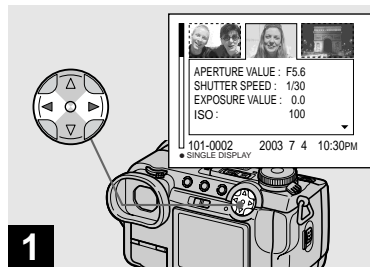

- 1** → While an index (triple-image) screen (page 34) is displayed, set the image you want to delete to the center with **◀▶** on the control button.

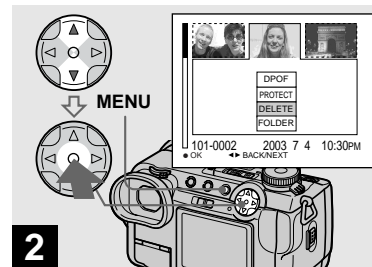

- 2** → Press **MENU** and select **[DELETE]** with **▲/▼** on the control button, then press **●**.

The image has not yet been deleted at this point.

## Formatting a "Memory Stick"

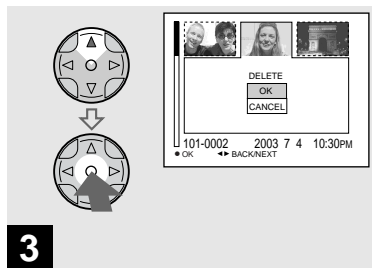

➔ Select [OK] with ▲ on the control button, then press ●.

"MEMORY STICK ACCESS" appears on the screen. When this message disappears, the image has been deleted.

### To cancel deleting

Select [CANCEL] with ▼ on the control button, then press ●.

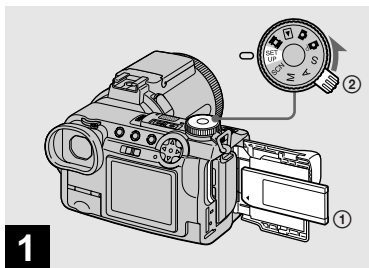

➔ Insert the "Memory Stick" you want to format into the camera. Set the mode dial to SET UP, and turn on the power.

- The term "formatting" means preparing a "Memory Stick" to record images; this process is also called "initialization." The "Memory Stick" provided with this camera, and those available commercially, are already formatted, and can be used immediately.
- **When you format a "Memory Stick," be aware that all data in the "Memory Stick" will be permanently erased.**

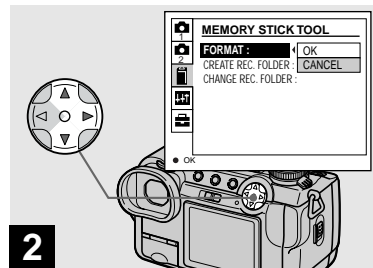

➔ Select  (MEMORY STICK TOOL) with ▲/▼ on the control button. Select [FORMAT] with ►, then press ►. Select [OK] with ▲, then press ●.

### To cancel the formatting

Select [CANCEL] with ▼ on the control button, then press ●.



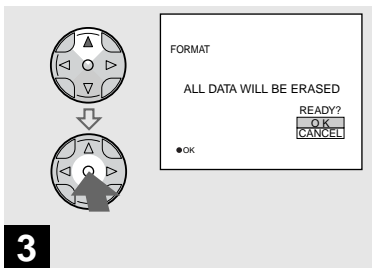

**3**

→ **Select [OK] with ▲ on the control button, then press ●.**

The “FORMATTING” message appears.  
When this message disappears, the format is complete.

## How to setup and operate your camera

The usage of the menus and SET UP screen items that are most frequently used for “Advanced operations” is described below.

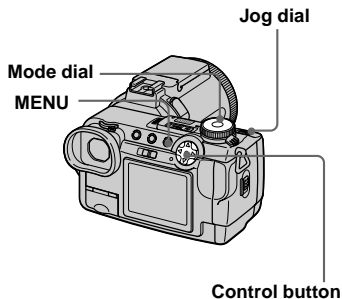

### Changing the menu settings

#### 1 Press MENU.

The menu appears.

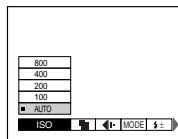

#### 2 Press ◀▶ on the control button to select the item you want to set.

The selected item turns yellow.

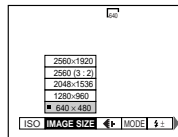

#### 3 Press ▲▼ on the control button to select the desired setting.

The frame of the selected setting turns yellow, and the setting is entered.

### To turn off the menu display

Press MENU.

### Changing the items in the SET UP screen

#### 1 Set the mode dial to SET UP.

The SET UP screen appears.

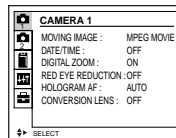

#### 2 Press ▲▼/◀▶ on the control button to select the item you want to set.

The frame of the selected item turns yellow.

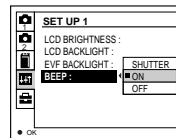

#### 3 Press ● on the control button to enter the setting.

### To turn off the SET UP screen display

Set the mode dial to anything other than SET UP.

## How to use the jog dial

The jog dial is used to change the setting values when shooting with the manual adjustment modes (shutter speed priority mode, aperture priority mode, manual exposure mode), EV adjustment or choosing the focus mode.

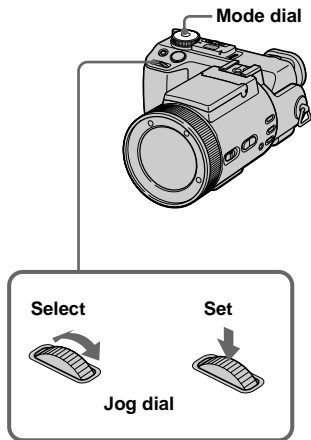

- 1 Set the mode dial to P, S, A, M, SCN or .**

The adjustable values appear on the right side of the screen.

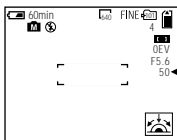

- 2 Turn the jog dial to select the item you want to adjust.**

Move the yellow indication to select the item.

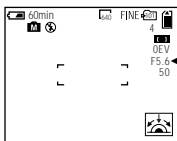

- 3 Press the jog dial.**

The value turns yellow.

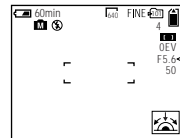

- 4 Turn the jog dial to select the value you want to set.**

The displayed value is set.

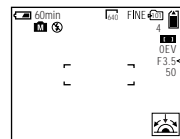

- 5 To set other items, press the jog dial, then repeat steps 2 to 4.**

## Shooting with the manual adjustments

### Mode dial: S/A/M

You can manually adjust the shutter speed and aperture values according to the purpose of shooting.

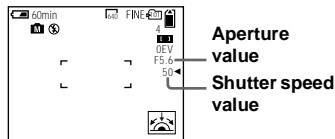

Mode dial	Description
S	Shutter speed priority mode. Other settings are automatically adjusted to attain correct exposure according to the brightness of the subject.
A	Aperture priority mode. Other settings are automatically adjusted to attain correct exposure according to the brightness of the subject.
M	Mode for manually adjusting both the shutter speed and aperture values to achieve the desired shooting condition.

- You cannot use the NightShot or NightFraming functions when the mode dial is set to S, A or M.
- You cannot make manual adjustments when shooting movies.
- If the proper exposure is not obtained after making the settings, the setting value indicators on the screen may flash when the shutter button is pressed halfway down. You can shoot in this condition, but we recommend that you adjust the flashing values again.
- The auto flash function does not operate.
- You can adjust an exposure value when the mode dial is set to S or A (page 49).

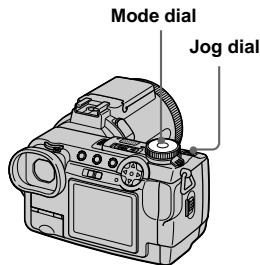

## Shutter speed priority mode

This function lets you shoot a fast-moving subject with its motion frozen, or the flow motion of a moving subject.



1/1000 s (shortest) 30 s (longest)

### 1 Set the mode dial to S.

### 2 Select a shutter speed.

Select a shutter speed with the jog dial (page 43). The shutter speed can be selected from 1/1000 to 30 seconds. If you select a shutter speed of 1/25 second or slower, “NR” is displayed before the shutter speed and the NR slow shutter mode is automatically activated.

- Shutter speeds of one second or longer are indicated with ["] after the value, such as 1".

## NR slow shutter

The NR slow shutter function removes noise from recorded images to provide clean, crisp images. Using a tripod is recommended to prevent shaking.

Press the shutter button fully down.

↓  
Exposure is performed for the set shutter speed time, the screen turns black, and “CAPTURING” is displayed.

↓  
Processing is performed to reduce noise for the set shutter speed time, and “PROCESSING” is displayed. The shutter sounds at this time.

↓  
When “PROCESSING” disappears, the image is recorded.

## Aperture priority mode

This function lets you change the focus depth to bring both the subject and background into focus or to shoot a subject with a fuzzy background.



Aperture value F2  
(minimum)



Aperture value F8  
(maximum)

- 1 Set the mode dial to A.**
- 2 Select an aperture value.**

Select an aperture value with the jog dial (page 43). The aperture value can be selected from F2 to F8.

- The range of values that can be selected varies, depending on the zoom position.
- The shutter speed is automatically adjusted from 1/1000 to 8 seconds. When you set an aperture value of F5.6 or more, the values start from 1/2000 second.

## Manual exposure mode

You can manually adjust the shutter speed and aperture values to achieve the desired shooting condition according to your purpose.

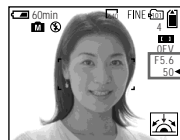

The difference between the set value and the appropriate exposure determined by the camera is displayed on the screen as the EV value (page 49). 0EV indicates that the most suitable value has been set by the camera.

- 1 Set the mode dial to M.**
- 2 Select the shutter speed value indication.**
- 3 Select the aperture value indication.**

Select the shutter speed value indication with the jog dial (page 43).

Select the aperture value indication with the jog dial (page 43).

## Choosing a focus method

**Mode dial:** 

### Focus range select function

You can select from six AF ranges: Multipoint AF, Center, Left, Right, Bottom and Top.

When you select the Center, Left, Right, Bottom and Top modes, the focus is adjusted automatically to the desired point within the AF range finder by AF operation.



### Multipoint AF

When you use Multipoint AF, the camera calculates the distance in three places to the left and right and in the center of the image, letting you shoot using the auto focus function without worrying about the image composition. This is useful when it is difficult to focus on the subject because it is not in the center of the frame.

The Multipoint AF is the factory setting.





Jog dial

Mode dial

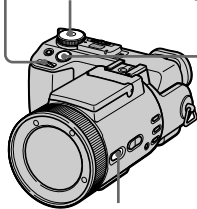
Shutter



FOCUS switch

**1** Set the mode dial to , P, S, A, M, SCN or .

**2** Set FOCUS switch to AUTO/ZOOM.

**3** Select the desired AF range.

Select the AF range with the jog dial (page 43).

You can select the AF range from Multipoint AF, Center, Left, Right, Bottom and Top.



When you press the shutter halfway down, the color of the AF range finder frame changes from white to green when focus is achieved.

- When you use digital zoom or the hologram AF, AF operates with priority on subjects in or near the center of the frame. In this case, the AF range finder frame is not displayed.
- When you select Multipoint AF in step 3, the automatically adjusted AF range finder frame appears in green when focus is achieved.



## Shooting with AF lock

When it is difficult to focus because the subject is not in the center of the frame, you can focus using the Focus range select function. For example, when shooting two human subjects with a gap between them, the camera may focus on the background visible through the gap. In these cases, use AF lock to ensure the subjects are in correct focus.

- AF lock lets you capture an image with the correct focus even if the subject is at the edge of the frame.

**1** Set the mode dial to **P, S, A, M, SCN** or **Clip Motion/Multi Burst**).

**2** Set **FOCUS** switch to **AUTO/ZOOM**.

**3** Compose the shot so that the **subject is centered in the AF range finder frame, then press and hold the shutter button halfway down.**

The camera focuses on the subject. When the AE/AF lock indicator changes from flashing to lighted up and there is a beeping sound, the focus adjustment is completed.



AF range finder

AE/AF lock indicator

**4 Return to the fully composed shot, and press the shutter button fully down.**

The image will be recorded with the proper focus for the subjects.



- You can carry out the AF lock adjustment process any number of times before you press the shutter button fully down.

## Focusing manually

**Mode dial:** P/S/A/M/SCN/

Normally the focus is automatically adjusted. This function is useful when the auto focus does not work well, such as in dark places.

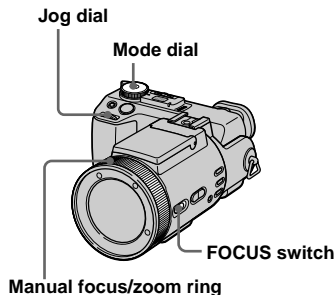

**1 Set the mode dial to P, S, A, M, SCN or .**

**2 Set FOCUS switch to MANUAL.**

The (manual focus) indicator appears on the screen.

**3 Turn the manual focus/zoom ring to achieve a sharp focus.**

The focus mode indicator is displayed.

If [EXPANDED FOCUS] in the SET UP settings is set to [ON], the image is zoomed to 2×\* when recording still images. When a sharp focus is achieved, the image returns to normal and the (manual focus) indicator changes from yellow to white. When recording a movie (MPEG MOVIE), or [EXPANDED FOCUS] is set to [OFF], the image is not zoomed. You can adjust the focus distance from 2 cm (13/16 inches) to ∞(infinite).

\* When using digital zoom, the image is zoomed 1× to 2×, depending on the digital zoom magnification.

### To reactivate auto focusing

Set FOCUS switch to AUTO/ZOOM.

- The focus mode indicator is approximate, and should be used as a reference.
- The focus distance value does not appear when NightShot is set and [CONVERSION LENS] is set to [ON] in the SET UP settings. When the indicator flashes, the focus distance has reached 2 cm (13/16 inches) or ∞.
- You cannot focus manually when using the NightFraming function.
- You cannot record images in macro when focusing manually.
- When you use the zoom function, use the ZOOM button (page 23).



## Adjusting the exposure

### — EV adjustment

Mode dial: P/S/A/SCN/

This lets you adjust the exposure value which is set by automatic adjustment. You can select values ranging from +2.0EV to -2.0EV in steps of 1/3EV.

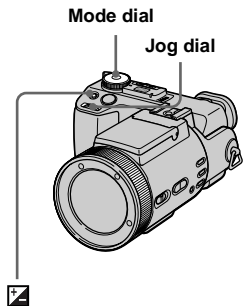

**1** Set the mode dial to P, S, A, SCN or M.

**2** Press Fn.

**3** Select the desired exposure value with the jog dial.

Adjust the exposure value while checking the brightness of the background.

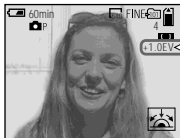

### To reactivate auto exposure

Return the exposure adjustment value to 0EV.

- If a subject is being shot in extremely bright or dark conditions, or the flash is used, the exposure adjustment may not be effective.

### Shooting techniques

Normally, the camera automatically adjusts the exposure. If the image is too dark or too bright as shown below, we recommend that you adjust the exposure manually. When shooting a back-lit subject or a subject against a white (e.g. snowy) background, adjust the exposure toward the + side. When shooting a brightly lit subject (e.g. spotlight) against a dark background, adjust the exposure toward the - side.



**Underexposed**

→ Adjust toward +



**Appropriate exposure**



**Overexposed**

→ Adjust toward -

## Displaying a histogram

A histogram is a graph showing the brightness of the pixels contained in an image. The horizontal axis shows the brightness, and the vertical axis shows the number of pixels. Displaying a histogram during recording or playback lets you determine the proper exposure.





- 1** Set the mode dial to , S, A or SCN.
- 2** Press DISPLAY to display the histogram.
- 3** Adjust the exposure based on the histogram.



**Adjusting the exposure to the + side shifts the histogram to the right side.**



**Adjusting the exposure to the – side shifts the histogram to the left side.**

- The histogram also appears when the mode dial is set to  or M, but you cannot adjust the exposure.
- The histogram also appears when you press DISPLAY while playing back a single image (page 33) or during Quick Review (page 21).
- The histogram does not appear in the following cases:
  - When the mode dial is set to SET UP or 
  - When the menu is displayed
  - During Quick Review of an image recorded in Exposure Bracket mode
  - When using playback zoom

-  appears in the following cases:
  - When recording in the digital zoom range
  - During recording or playback in [2560 (3:2)] size
  - When rotating a still image
- The histogram before recording represents the histogram of the image displayed on the screen at the that time. A difference occurs in the histogram before and after you press the shutter button. When this happens, check the histogram while playing back a single-image or during Quick Review.  
In particular a large difference appears in the following cases:
  - When the flash strobes
  - When using the NightFraming function
  - When [P. EFFECT] is set to [SOLARIZE]
  - During slow shutter or high-speed shutter
- The histogram may not appear for images recorded using other cameras.

## Metering mode

**Mode dial:** P/S/A/M/SCN/

This function enables you to select the metering mode to suit the shooting conditions and purpose.

### Multi-pattern metering (No indicator)

The image is divided into multiple regions and metering is performed for each region. The camera judges the subject position and background brightness, and determines a well-balanced exposure. The camera is set to multi-pattern metering as the factory setting.

### Center-weighted metering ()

Metering is performed with priority given to the center of the image. The camera determines the exposure based on the brightness of a subject near the center according to the shooting aim.

### Spot metering ()

Light is measured only for the specific region where the subject is located. This lets you adjust the exposure to the subject even when the subject is backlit or there is strong contrast between the subject and the background.

Position the spot metering cross hair on one point of the subject you want to shoot.

- To focus on the same spot as used for metering, we recommend using the Focus range select function (Center) (page 46).
- You cannot set the metering mode when using the NightShot and NightFraming functions.

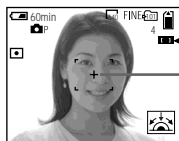

Spot metering cross hair

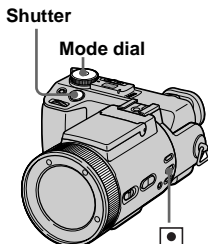

**1** Set the mode dial to P, S, A, M, SCN or .

**2** Press repeatedly to select the desired setting.

Each time you press , the metering mode changes as follows:

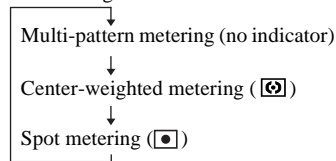

**3** Shoot the image.

Press and hold the shutter button halfway down, wait until the camera completes the automatic adjustments, then press the shutter button fully down to record the image.



## Shooting with the exposure fixed

### — AE LOCK

Mode dial: 

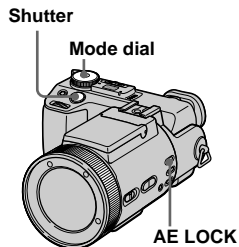
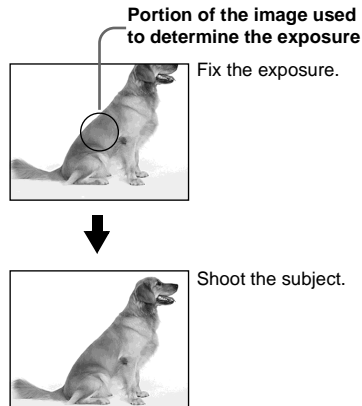
Once you press AE LOCK, the exposure is fixed. This function lets you measure the desired portion of the image using the spot metering function, fix that exposure value by pressing AE LOCK, and then recompose the picture.



- 1** Set the mode dial to , P, S, A, SCN or .
- 2** Focus on a portion of the image that has the desired exposure value, then press AE LOCK.

The exposure is fixed and the AE-L indicator appears.



- 3** Target the subject you want to shoot and press and hold the shutter button halfway down.  
The focus is automatically adjusted.
- 4** Press the shutter button fully down.

### To release AE LOCK

Carry out one of the followings:

- Press AE LOCK again after step **2**.
- Release your finger from the shutter button after step **3**.
- Press down the shutter button in step **4**.

## Shooting three images with the exposure shifted

### — Exposure Bracket

Mode dial: / P/S/A/M/SCN

The camera records three images in succession, each with the exposure value shifted. The exposure compensation value can be set between  $\pm 1.0\text{EV}$  from the appropriate exposure value in  $1/3\text{EV}$  steps.

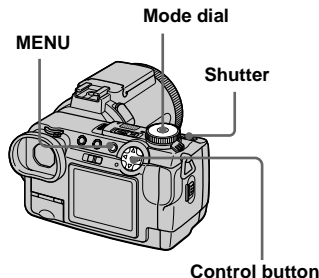

- 1** Set the mode dial to SET UP.  
The SET UP screen appears.
- 2** Select 2 (CAMERA 2) with  $\blacktriangle/\blacktriangledown$  and [BRACKET STEP] with  $\blacktriangleright/\blacktriangleleft/\blacktriangledown$ , then press  $\blacktriangleright$ .
- 3** Select the desired bracket step value with  $\blacktriangle/\blacktriangledown$ , then press  $\bullet$ .  
 $\pm 1.0\text{EV}$ : Shifts the exposure value by plus or minus 1.0EV.  
 $\pm 0.7\text{EV}$ : Shifts the exposure value by plus or minus 0.7EV.  
 $\pm 0.3\text{EV}$ : Shifts the exposure value by plus or minus 0.3EV.
- 4** Set the mode dial to , P, S, A, M or SCN.
- 5** Press MENU.  
The menu appears.
- 6** Select [MODE] (REC MODE) with  $\blacktriangleleft/\blacktriangleright$ , then select [EXP BRKTG] with  $\blacktriangle/\blacktriangledown$ .
- 7** Shoot the image.

## To return to normal mode

Select [NORMAL] in step 6.

- You cannot use the flash in this mode.
- During shooting in this mode, the images are not displayed on the screen. Compose the image before pressing the shutter button.
- The focus and white balance are adjusted for the first image, and these settings are also used for the other images.
- When the exposure is manually adjusted, the adjusted value is used for the center value.
- The recording interval is approximately 0.5 second.
- You cannot select a shutter speed of 1/25 second or slower.

## Adjusting color tones

### — White Balance

**Mode dial:**  P/S/A/M/SCN/

Normally, when recording with automatic adjustments, the white balance is automatically set to AUTO and the overall color balance is adjusted according to the shooting conditions. However, when you shoot under fixed conditions or special lighting conditions, you can manually adjust the white balance.

#### **AUTO (no display)**

Adjusts the white balance automatically

#### (ONE PUSH)

For adjusting the white balance depending on the light source

#### (Daylight)

Shooting outdoors, or shooting a sunrise/sunset, night scene, neon signs, or fireworks

#### (Cloudy)

Shooting under a cloudy sky



#### (Fluorescent)

Shooting under fluorescent lighting

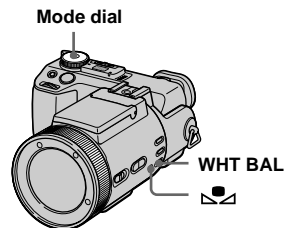

#### (Incandescent)

- Places where the lighting conditions change quickly
- Under bright lighting such as photography studios







- 1** Set the mode dial to  P, S, A, M, SCN or .
- 2** Press WHT BAL repeatedly to select the desired setting.

## To shoot in one-push white balance mode

- 1 Frame a white object such as a piece of paper filling the screen under the same lighting conditions as you will shoot the subject.
- 2 Press .  
The  indicator flashes quickly. When the white balance has been adjusted and stored in the memory, the indicator stops flashing.  
Do not move the camera while the  indicator is flashing.

## To reactivate auto adjustment

Select [AUTO] in step **2**.

- Under fluorescent lights that flicker, the white balance adjustment function may not work correctly even though you select  (fluorescent).
- When the flash strobes, the manual setting is canceled, and the image is recorded in [AUTO] mode.
- The  indicator means:  
Slow flashing: The white balance is not set or was not able to be set.  
Quick flashing: The white balance is being adjusted (after you press ).  
Lit steady: The white balance has been set.
- If the  indicator keeps flashing even when you press , record in automatic white balance mode.
- When you select the one-push white balance mode, the screen momentarily turns blue.

- You cannot adjust the white balance when using the NightShot and NightFraming functions.

### Shooting techniques

The image is affected by the lighting conditions. For example, the entire image appears blue under sunlight in the summer, and white items gain a reddish tint under incandescent light bulbs, etc. The human eye can resolve these problems, but digital still cameras cannot recognize the correct colors without adjustments. Normally, the camera makes these adjustments automatically, but if recorded image colors appear unnatural, we recommend that you adjust the white balance.

## Shooting in the dark

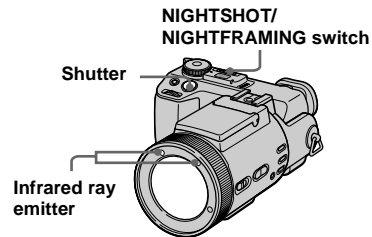

Mode dial:  /  / 



- Filters (not supplied) may block the infrared ray.
- The recommended recording distance for the NightShot or NightFraming function is from approx. 0.3 m to 4.5 m (11 7/8 inches to 177 1/4 inches).
- You cannot use the NightShot or NightFraming function when [CONVERSION LENS] is set to [ON] in the SET UP settings (page 110).

## NightShot

The NightShot function lets you shoot subjects in dark places such as camp scenes at night or nocturnal plants and animals.

**1 Set the mode dial to ,  or .**

**2 Set NIGHTSHOT/NIGHTFRAMING switch to NIGHTSHOT.**

The  and “NIGHT SHOT” indicators light. The “NIGHT SHOT” indicator turns off after 5 seconds.

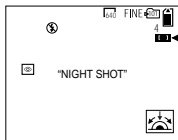



**3 Shoot the image.**

### To cancel the NightShot function



Set NIGHTSHOT/NIGHTFRAMING switch to .

- While using the NightShot function, you cannot use the following functions:
  - White balance
  - Switching the metering mode
  - AE LOCK
  - Shooting with hologram AF
  - Shooting with the flash
- Do not use the NightShot function in bright places (e.g. outdoors in the daytime). This may cause your camera to malfunction.
- Images do not appear with the correct colors while shooting with the NightShot function.
- If focusing is difficult with the auto focus mode when using the NightShot function, adjust focus manually (page 48). The focus distance value does not appear.
- If you press an invalid key while using the NightShot function, the  indicator flashes, and the “NIGHT SHOT” indicator lights for about 5 seconds.

However, if you select the flash mode in Bracket, Multi Burst or BURST 3 mode, the BRK/   indicator flashes.

## NightFraming

The NightFraming function enables you to check a subject even at night and then record with natural colors using the flash.

**1 Set the mode dial to ,  or .**

**2 Set NIGHTSHOT/NIGHTFRAMING switch to NIGHTFRAMING.**

The  and “NIGHT FRAMING” indicators light. The “NIGHT FRAMING” indicator turns off after about 5 seconds.



**3 Press and hold the shutter button halfway down.**

The hologram AF light (page 27) is emitted and the focus is automatically adjusted.

**4 Press the shutter button fully down.**

The shutter sounds, the flash strobes and the image is recorded.



## To cancel the NightFraming function

Set NIGHTSHOT/NIGHTFRAMING switch to ●.

- While using the NightFraming function, you cannot use the following functions:
  - White balance
  - Switching the metering mode
  - AE LOCK
  - Manual focus
- When you press the shutter button halfway down you will hear a sound, but this is not the sound of the shutter releasing. The image is not recorded yet.
- The flash does not function when recording in BURST 3 and in EXP BRKTG modes. The BRK/📄 indicator flashes.
- If you perform any other invalid operation while using the NightFraming function, the 📄 indicator flashes and the “NIGHT FRAMING” indicator lights for about 5 seconds.

## Shooting multiple frames

### — Clip Motion

#### Mode dial: 📄

You can shoot a number of consecutive still images (GIF animation). The GIF format has a small file size, making it convenient for creating home pages or attaching images to e-mail.

- Due to the limitations of the GIF format, the number of colors for Clip Motion images is reduced to 256 colors or less. Therefore, the image quality may deteriorate for some images.

#### NORMAL (160×120)

Clip Motion of up to 10 frames can be recorded. This is suitable for use on home pages, etc.

#### MOBILE (120×108)

Clip Motion of up to two frames can be recorded. This is suitable for use with portable data terminals.

- The file size is reduced in MOBILE mode, so the image quality deteriorates.
- For the number of images you can record in Clip Motion mode, see page 104.

## Before operation

Set [MOVING IMAGE] to [CLIP MOTION] in the SET UP settings (pages 42 and 110).

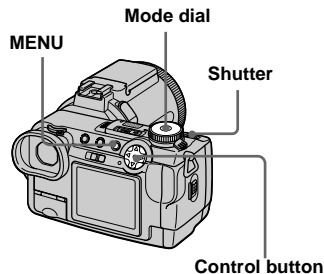

- 1 Set the mode dial to 📄.**
- 2 Press MENU.**  
The menu appears.
- 3 Select 📄 (IMAGE SIZE) with ◀, then select the desired mode with ▲/▼.**

**4 Shoot the image for the first frame.**

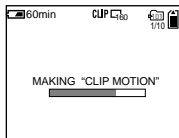

**5 Shoot the image for the next frame.**

Press the shutter button to shoot the next frame, then repeat this operation until you have shot the desired number of frames.

**6 Press ●.**

All the frame images are recorded on the “Memory Stick”.

**To delete some or all of the frame images while making a Clip Motion recording**

- 1 Press ◀ (Ⓢ) in step **4** or **5**.  
The frame images you shot are played back in turn and stop at the last image.
- 2 Press MENU, and select [DELETE LAST], or [DELETE ALL] with ◀/▶, then press ●.
- 3 Select [OK] with ▲, then press ●. When [DELETE LAST] is selected in step **2**, each time you repeat steps **1** through **3**, the last frame you shot is deleted.

- Before carrying out step **6**, the images are saved temporarily in the camera memory. These images are not recorded on the “Memory Stick” yet.
- The date and time are not superimposed onto Clip Motion images.
- When viewing an image recorded in Clip Motion on the index screen, the image may appear different from the actual image.
- GIF files not created on this camera may not be displayed correctly.

---

## Shooting in Multi Burst mode

### — Multi Burst

**Mode dial:**

This mode records 16 frames in succession each time you press the shutter button. This is convenient for checking your form in sports, for example.



### Before operation

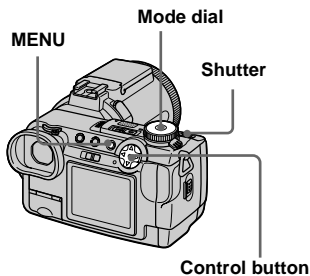

Set [MOVING IMAGE] to [MULTI BURST] in the SET UP settings (pages 42 and 110).



**1** Set the mode dial to .

**2** Press MENU.

The menu appears.

**3** Select  (INTERVAL) with , then select the desired frame interval with .

You can choose the frame interval from the menu settings (page 108).





#### 4 Shoot the image.

The 16 frames are recorded as a single image (image size: 1280×960).

#### To delete recorded images

When using this mode, you cannot delete only selected images within the Multi Burst sequence. When you delete images, all 16 images are deleted at the same time.

- 1 Set the mode dial to .
- 2 Press MENU and select [DELETE] from the menu, then press .
- 3 Select [OK], and press . All of the images are deleted.

- You cannot use the flash in this mode.
- When you play back images recorded with this camera in Multi Burst mode, the 16 frames will be played back in order at a fixed interval.
- When the images are played back on a computer, all 16 frames will be displayed at the same time as part of one image.
- When Multi Burst images are played back on a camera without the Multi Burst feature, all 16 frames will be displayed at the same time as part of one image, just as they are on a computer.
- Date and time cannot be superimposed onto images.
- For the number of images that can be recorded in Multi Burst mode, see page 105.

## Shooting three images continuously

### — Burst

**Mode dial:**  /  / S / A / M / SCN

This mode is used for continuous shooting. Each time you press the shutter button in this mode, the camera records three images in succession.

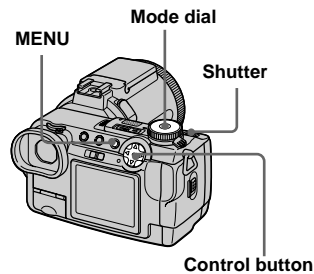

**1** Set the mode dial to , , S, A, M or SCN.

**2** Press MENU.

The menu appears.

**3** Select [MODE] (REC MODE) with , then select [BURST 3] with .

**4** Shoot the image.

When the “RECORDING” indication disappears, you can shoot the next image.

### To return to normal mode

Select [NORMAL] in step **3**.

- You cannot use the flash in this mode.
- During shooting in this mode, the images are not displayed on the screen. Compose the image before pressing the shutter button.
- The recording interval is approximately 0.5 second.
- You cannot select a shutter speed of 1/25 second or slower.

## Shooting still images in TIFF mode

### — TIFF

Mode dial: / P/S/A/M/SCN

This mode records an image without compression, so the image quality does not deteriorate. Images recorded in this mode are suitable for printing with a high-quality image. A JPEG (compressed) format image is also recorded at the same time.

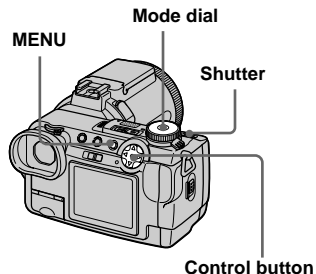

**1** Set the mode dial to , , S, A, M or SCN.

**2** Press MENU.

The menu appears.

**3** Select [MODE] (REC MODE) with , then select [TIFF] with .

**4** Shoot the image.

When the “RECORDING” indication disappears, you can shoot the next image.

### To return to normal mode

Select [NORMAL] in step **3**.

- JPEG images are recorded in the image size selected by the (IMAGE SIZE) menu (page 19). TIFF images are recorded in [2560×1920] size except when [2560 (3:2)] is selected.
- Writing data takes more time than in normal recording mode.
- For the number of images you can record in TIFF mode, see page 104.

## Shooting still images for e-mail

### — E-mail

**Mode dial:** / P/S/A/M/SCN

In E-mail mode, a small-size image (320×240) that is suitable for e-mail transmission is also recorded at the same time as recording a normal still image. (See page 19 for the normal still image sizes.)

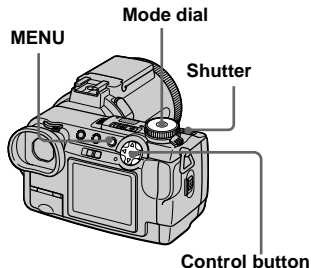

**1** Set the mode dial to , P, S, A, M or SCN.

**2** Press MENU.  
The menu appears.

**3** Select [MODE] (REC MODE) with / , then select [E-MAIL] with / .

**4** Shoot the image.  
When the “RECORDING” indication disappears, you can shoot the next image.

### To return to normal mode

Select [NORMAL] in step **3**.

- For instructions on how to attach images to an e-mail message, consult the User's Manual for your e-mail software.
- For the number of images you can record in E-mail mode, see page 104.

## Shooting still images with audio files

### — Voice

**Mode dial:** / P/S/A/M/SCN

In Voice mode, an audio track is also recorded at the same time as recording a normal still image.

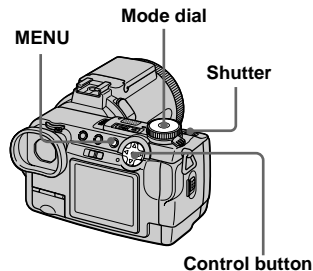

**1** Set the mode dial to , P, S, A, M or SCN.

**2** Press MENU.  
The menu appears.

**3** Select [MODE] (REC MODE) with / , then select [VOICE] with / .

#### 4 Shoot the image.

When the “RECORDING” indication disappears, you can shoot the next image.

**If you press and release the shutter button**, sound is recorded for five seconds.

**If you hold down the shutter button**, sound is recorded until you release the shutter button for up to 40 seconds.

#### To return to normal mode

Select [NORMAL] in step 3.

- To view images recorded in Voice mode, see page 76.
- For the number of images you can record in Voice mode, see page 104.

## Adding special effects

### — Picture Effect

**Mode dial:** P/S/A/M/SCN/

You can digitally process images to obtain special effects.

#### SOLARIZE



The light contrast is clearer and the picture looks like an illustration.

#### SEPIA



The picture is sepia-toned like an old photograph.

#### NEG.ART



The color and brightness of the picture are reversed as in a negative.

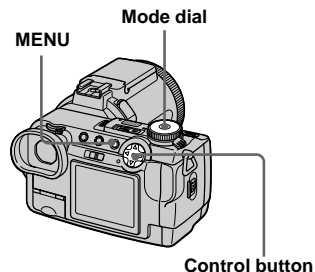

**1** Set the mode dial to P, S, A, M, SCN or .

**2** Press MENU.

The menu appears.

**3** Select [PFX] (P. EFFECT) with /▶, then select the desired mode with ▲/▼.

#### To cancel Picture Effects

Select [OFF] in step 3.

## Using an external flash

**Mode dial:** / P/S/A/M/SCN/

- The flash does not strobe when shooting in Burst, Exposure Bracket, Twilight, MPEG Movie or Multi Burst mode.
- When an external flash is mounted, the weight prevents the lens portion from locking. We recommend supporting the lens portion with your left hand or using a tripod for recording.
- You cannot have an external flash and the built-in flash strobe at the same time.

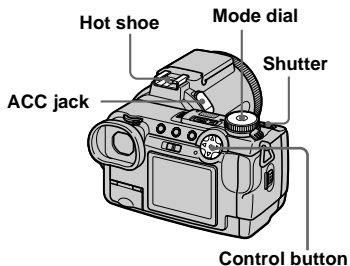

## Using the Sony HVL-F1000 Flash

You can mount the Sony HVL-F1000 flash on the hot shoe of your camera. Using the HVL-F1000 will allow you to shoot more vivid flash pictures than when using an ordinary external flash.

- 1 Mount the HVL-F1000 external flash on the hot shoe.**
- 2 Plug the flash into the ACC jack.**
- 3 Turn on the HVL-F1000.**
- 4 Set the mode dial to , P, S, A, M, SCN or (Clip Motion).**
- 5 Shoot the image.**

The built-in flash does not strobe.

- When using a Sony optional external flash, set [HOT SHOE] to [OFF] in the SET UP settings.

## Using a commercially available external flash

You can mount a commercially available external flash that supports hot shoe.

- 1 Mount the external flash to the hot shoe.**
- 2 Set the mode dial to SET UP.**
- 3 Select 2 (CAMERA 2) with , [HOT SHOE] with , [ON] with , then press .**
- 4 Turn on the external flash.**
- 5 Set the mode dial to M or A.**

For details, please consult the operating instructions supplied with your flash.

The flash also strobes when the mode dial is set to , P, S, SCN or (Clip Motion), but we recommend recording with the mode dial set to M or A.

- 6 Shoot the image.**

- Set the most appropriate aperture value according to the guide number of the flash used and the distance to the subject.
- The flash guide number varies according to the ISO sensitivity (page 107) of the camera, so be sure to check the ISO number.
- Note that the camera may not function properly or may malfunction when using a flash manufactured by another company for a specific camera (generally a flash with multiple contact points on the hot shoe), a high-voltage type flash, or a flash accessory.
- If you record with [HOT SHOE] set to [OFF] in the SET UP settings, the built-in flash may rise up. If this happens, return the built-in flash to its original position. Depending on the type of external flash used, you may have to remove the external flash before returning the built-in flash to its original position.

## Selecting a folder

### Mode dial: SET UP

Your camera can create multiple folders within a “Memory Stick.”  
Creating multiple folders makes it easy to find images during playback.

The “101MSDCF” folder is set as the recording folder at the factory. You can create folders up to “999MSDCF”.

- Up to 4000 images can be stored in one folder. When the folder capacity is exceeded, a new folder is automatically created.
- Once you create a folder, it cannot be deleted.

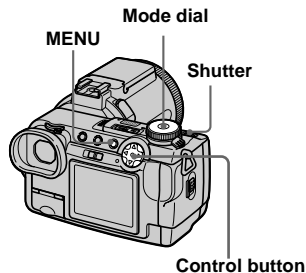

## Creating a new folder

- 1** Set the mode dial to SET UP.
- 2** Select (MEMORY STICK TOOL) with ▲/▼, then select [CREATE REC. FOLDER] with ►/▲/▼.

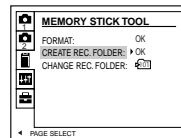

- 3** Select [OK] with ►/▲, then press ●.



- 4** Select [OK] with ▲, then press ●.

A new folder is created with a number one higher than the last created folder.



## To cancel folder creation

Select [CANCEL] in steps **3** or **4**.

- Shooting images are recorded in the newly created folder until a different folder is created or selected.

## Changing the recording folder

**1** Set the mode dial to SET UP.

**2** Select  (MEMORY STICK TOOL) with  $\blacktriangle/\blacktriangledown$ , then select [CHANGE REC. FOLDER] with  $\blacktriangleright/\blacktriangledown$ .

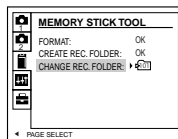

**3** Select [OK] with  $\blacktriangleright/\blacktriangle$ , then press  $\bullet$ .

The recording folder selection screen appears.

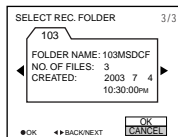

**4** Select the desired folder with  $\blacktriangle/\blacktriangleright$ , and [OK] with  $\blacktriangle$ , then press  $\bullet$ .

## To cancel changing the recording folder

Select [CANCEL] in steps **3** or **4**.

- Images recorded using a camera without the folder creation function are stored in the "100MSDCF" folder. You cannot select "100MSDCF" as the recording folder with this camera.

## Selecting a playback folder

Mode dial: 

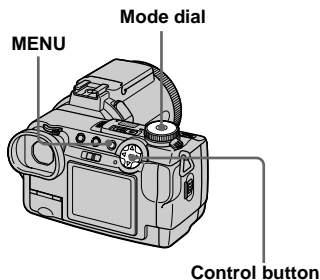

You can set the playback folder.



**1** Set the mode dial to .

**2** Press MENU.

The menu appears.

**3** Select [FOLDER] with  on the control button, then press .

**4** Display the folder to be played back with / .

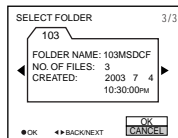

**5** Select [OK] with , then press





### To cancel playback folder selection

Select [CANCEL] in step **4** or **5**.

### When a “Memory Stick” contains multiple folders

The following marks appear on the first and last images in a folder (page 120).

: You can move to the previous folder.

: You can move to the next folder.

: You can move to both the previous and the next folders.

- You can also select the playback folder at the index (nine-image or triple-image) screen.
- You can also select the playback folder using [CHANGE REC. FOLDER] in the SET UP settings (page 65).
- If there are no images in the folder, the message “NO FILE IN THIS FOLDER” appears on the screen.



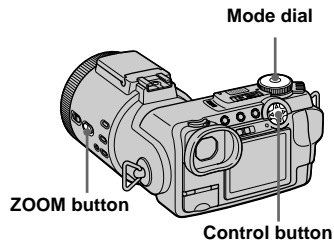

## Enlarging a portion of a still image

Mode dial: 

You can enlarge a part of an image up to five times the original size. You can also record the magnified image as a new file.



## Enlarging an image — Playback zoom

- 1 Set the mode dial to .
- 2 Display the image to be enlarged.
- 3 Press the zoom T button to zoom in on the image.
- 4 Select the desired portion of the image with ///.

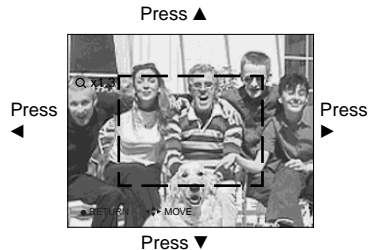

- ▲: To view more of the top of the image
- ▼: To view more of the bottom of the image
- ◀: To view more of the left side of the image
- ▶: To view more of the right side of the image

- 5 Adjust the image size with the ZOOM W/T button.





## To cancel playback zoom

Press ●.

- You cannot use playback zoom for movies (MPEG MOVIE), Clip Motion images and Multi Burst images.
- You can enlarge the images displayed with the Quick Review function (page 21) by performing steps 3 to 5.
- You cannot enlarge images with the manual focus/zoom ring.

## Recording an enlarged image — Trimming

- 1 Press MENU after playback zoom.
- 2 Select [TRIMMING] with , then press ●.
- 3 Select the image size with /, then press ●.

The recording folder appears at the upper right of the screen.

The image is recorded, and the image on the screen returns to the normal size after recording.

- The trimmed image is recorded as the newest file in the selected recording folder, and the original image is retained.
- The quality of trimmed images may deteriorate.
- You cannot trim to an image size of 3:2.
- You cannot trim uncompressed (TIFF) images.
- You cannot trim images displayed with Quick Review.

## Playing back successive images

### — Slide Show

#### Mode dial:

You can play back recorded images in order. This function is useful for checking your images or for presentations, etc.

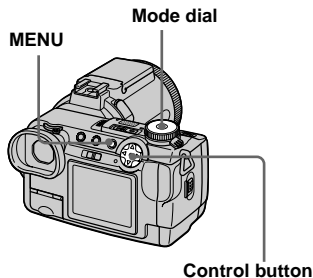





**1** Set the mode dial to .

**2** Press MENU.

The menu appears.

**3** Select [SLIDE] with , then press .

Set the following items with ///.

#### INTERVAL

3 sec/5 sec/10 sec/30 sec/1 min

#### IMAGE

FOLDER:

Plays back images in the selected folder.

ALL: Plays back all images stored in the “Memory Stick.”

#### REPEAT

ON: Plays back images in a continuous loop.

OFF: After all the images have been played back, the slide show ends.



**4** Select [START] with , then press .

The slide show begins.



### To cancel the slide show setting

Select [CANCEL] in step **3**.

### To stop slide show playback

Press , select [EXIT] with , then press  again.

### To skip to the next/previous image during the slide show

Press  (next) or  (previous). If [FOLDER] is selected in [IMAGE], only the images in the folder can be selected.

- The interval setting time may vary depending on the image size.

## Rotating still images

### Mode dial:

You can rotate an image recorded in portrait orientation and display it in landscape orientation. The rotated image is written over the original image.

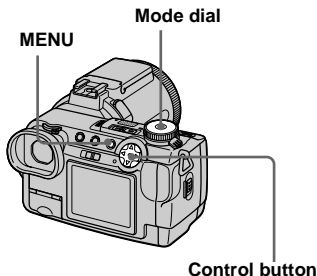



**1** Set the mode dial to , and display the image to rotate.

**2** Press MENU.

The menu appears.

**3** Select [ROTATE] with , then press .

**4** Select   with , then rotate the image with .

**5** Select [OK] with , then press .

The rotated image is written over the original image.

### To cancel rotation

Select [CANCEL] in step **4**, then press .

- You cannot rotate protected images and images recorded as movies (MPEG MOVIE), Clip Motion and Multi Burst images.
- You may not be able to rotate images shot with other cameras.
- When viewing images on a computer, the image rotation information may not be reflected depending on the application software.

## Protecting images

### — Protect

Mode dial: 

This function protects images against accidental erasure. Note that when you format a “Memory Stick” (page 40), all the images recorded on that “Memory Stick” will be deleted even if they are protected.

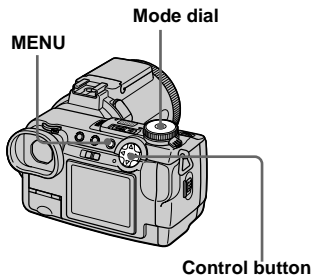





### In single-image mode



- 1** Set the mode dial to .
  - 2** Display the image you want to protect with / .
  - 3** Press MENU.
- The menu appears.
- 4** Select [PROTECT] with / , then press .

The displayed image is protected. The  (protect) indicator appears on the image.

















- 5** To continue and protect other images, select the desired image with /  and select [PROTECT] with , then press .

### To cancel the protection

Press  again in step **4** or **5**. The  indicator disappears.

### In index (nine-image) mode

- 1** Set the mode dial to , then press  to display the index (nine-image) screen.
  - 2** Press MENU.
- The menu appears.
- 3** Select [PROTECT] with / , then press .
  - 4** Select [SELECT] with / , then press .
  - 5** Select the image you want to protect with / / / , then press .
- The green  indicator appears on the selected image.



- 6** Repeat step **5** to protect other images.

**7 Press MENU.**

The menu appears.

**8 Select [OK] with  $\blacktriangleright$ , then press  $\bullet$ .**

The  $\text{On}$  indicator turns white. The selected images are protected.

**To exit the Protect function**

Select [CANCEL] in step **4** or select [EXIT] in step **3**, then press  $\bullet$ .

**To cancel individual protection**

Select the image to be unprotected with  $\blacktriangle/\blacktriangledown/\blacktriangleleft/\blacktriangleright$ , then press  $\bullet$  in step **5**. The  $\text{On}$  indicator turns gray. Repeat this operation for all images that are to be unprotected. Press MENU, select [OK], and then press  $\bullet$ .

**To protect all images in the folder**

Select [ALL IN FOLDER] in step **4**, and press  $\bullet$ . Select [ON], then press  $\bullet$ .

**To cancel all protection in the folder**

Select [ALL IN FOLDER] in step **4**, and press  $\bullet$ . Select [OFF], then press  $\bullet$ .

*In index (triple-image) mode*

**1 Set the mode dial to  $\blacktriangleright$ , then press  $\text{On}$  twice to display the index (triple-image) screen.****2 Display the image you want to protect in the center position with  $\blacktriangleleft/\blacktriangleright$ .****3 Press MENU.**

The menu appears.

**4 Select [PROTECT] with  $\blacktriangle/\blacktriangledown$ , then press  $\bullet$ .**

The center image is protected. The  $\text{On}$  indicator appears on the image.

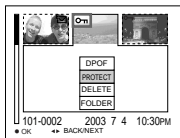
**5 To protect other images, display the image you want to protect in the center position with  $\blacktriangleleft/\blacktriangleright$ , and repeat step **4**.****To cancel previously set protection**

Select the image to be unprotected, and press  $\bullet$  in step **4**. To cancel protection of all images, repeat this process for each image.

## Changing image size

### — Resize

**Mode dial:** 

You can change the image size of a recorded image, and save it as a new file. You can resize to the following sizes. 2560×1920, 2048×1536, 1280×960, 640×480

The original image is retained even after resizing.

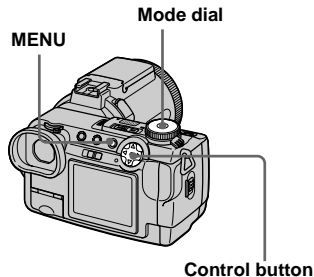

**1** Set the mode dial to .

**2** Display the image you want to resize with / .

**3** Press **MENU**.

The menu appears.

**4** Select **[RESIZE]** with , then press .

**5** Select the desired size with / , then press .

The recording folder appears at the upper right of the screen.

### To cancel resizing

Select **[CANCEL]** in step **5**.

- The resized image is recorded as the newest file in the selected recording folder, and the original image is retained.
- You cannot change the size of movies (MPEG MOVIE), Clip Motion, Multi Burst or TIFF images.
- When you change from a small size to a large size, the image quality deteriorates.
- You cannot resize to an image size of 3:2.
- When you resize a 3:2 image, the upper and lower black portions will be displayed on the screen.

## Choosing images to print

### — Print (DPOF) mark

**Mode dial:** 



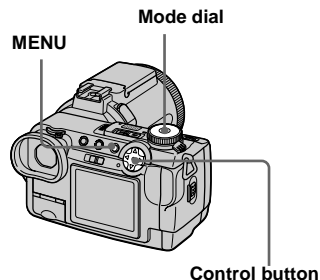



You can mark still images shot with your camera that you want to have printed. This function is convenient when you have images printed at a shop or using a printer that conforms with the DPOF (Digital Print Order Format) standard.









- You cannot mark movies (MPEG MOVIE) or Clip Motion images.
- In E-mail mode, a print (DPOF) mark is marked on the normal size image that is recorded at the same time.
- When you mark images shot in Multi Burst mode, all the images are printed on one sheet divided into 16 panels.
- If you mark an image shot in TIFF mode with a print (DPOF) mark, only the uncompressed image is printed, and the JPEG image recorded at the same time is not printed.

### In single-image mode



- 1** Set the mode dial to .
- 2** Display the image you want to print with  .
- 3** Press MENU.  
The menu appears.
- 4** Select [DPOF] with  , then press .

The  mark is marked on the displayed image.















- 5** To continue and print other images, select the desired image with   and select [DPOF] with , then press .

### To unmark the mark

Press  again in step **4**. The  mark disappears.

### In index (nine-image) mode

- 1** Set the mode dial to , then press  to display the index (nine-image) screen.
- 2** Press MENU.  
The menu appears.
- 3** Select [DPOF] with , then press .
- 4** Select [SELECT] with  , then press .
- 5** Select the image you want to print with    , then press .

- When marking print marks, you cannot select [ALL IN FOLDER].

The green  mark appears on the selected image.





- 6** Repeat step **5** to print other images.

## 7 Press MENU.

The menu appears.

## 8 Select [OK] with **▶**, then press **●**.

The  mark turns white. The  mark setting is completed.

### To exit the mark function

Select [CANCEL] in step **4**, or select [EXIT] in step **8**.

### To unmark selected marks

Select the images to be unmarked in step **5**, then press **●**.

### To unmark all the marks in the folder

Select [ALL IN FOLDER] in step **4**, then press **●**. Select [OFF], then press **●**.

### In index (triple-image) mode

## 1 Set the mode dial to , then press twice to display the index (triple-image) screen.

## 2 Display the image you want to print in the center position with **◀▶**.

## 3 Press MENU.

The menu appears.

## 4 Select [DPOF] with **▲**, then press **●**.

The  mark is marked on the center image.

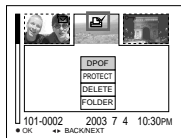

## 5 To print other images, display the image you want to print in the center position with **◀▶**, and repeat step **4**.

### To unmark the mark

Press **●** again in step **4**. The  mark disappears.

## Shooting movies

**Mode dial:** 

You can shoot movies using your camera.

### Before starting

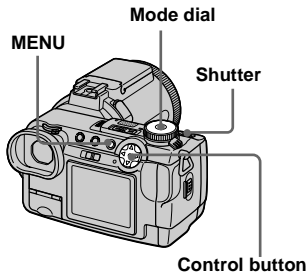

Set [MOVING IMAGE] to [MPEG MOVIE] in the SET UP settings (pages 42 and 110).



**1** Set the mode dial to .

**2** Press MENU.

The menu appears.

**3** Select  (IMAGE SIZE) with , then select the desired mode with .

You can choose from 320 (HQX), 320×240 or 160×112.

For details on the recording time for each image size, see page 105.

**4** Press the shutter button fully down.

“REC” appears on the screen and the camera starts recording the image and sound.



- Recording stops when the “Memory Stick” is full.

**5** Press the shutter button fully down again to stop recording.

### Indicators during shooting

- The screen indicators are not recorded.
- For a detailed description of the indicators, see page 119.
- A histogram is not displayed.

### Shooting close-ups (Macro)

Set the mode dial to  and follow the procedure on page 24.

### Using the self-timer

Set the mode dial to  and follow the procedure on page 25.

- The flash does not function when shooting movies.
- The date and time are not superimposed onto movies.
- When shooting movies (MPEG MOVIE) with Multipoint AF, the distance to the center of the screen is estimated as an average, so the AF works even with a certain amount of vibration. The Focus range select function (Center, Left, Right, Bottom and Top) focuses automatically using only the selected AF range finder. This is convenient when you want to focus only on the subject.



## Viewing movies on the screen

**Mode dial:** 

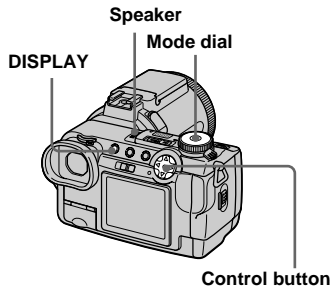
You can view movies on the screen with sound from the speaker.



**1** Set the mode dial to .

**2** Select the desired moving image with / .

The movie is displayed one size smaller than still images.



**3** Press .

The movie and sound are played back. During playback,  (PLAYBACK) appears on the screen.

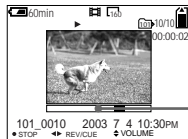



Playback bar



### To stop playback

Press  again.

### To adjust the volume

Press /  to adjust the volume.

### To advance or rewind the movie

Press /  during playback.

To return to the normal playback, press .

## High quality movies [320 (HQX)]

Movies are displayed over the entire screen.

### Indicators during viewing movies

- Each time you press DISPLAY, the status of the screen changes as follows:  
Indicators off → All indicators on.
- For a detailed description of the indicators, see page 120.
- A histogram is not displayed.
- The procedure for viewing movies on a TV is the same as that for viewing still images (page 35).

## Deleting movies







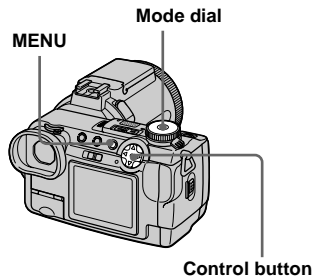





### — Delete

Mode dial: 

You can delete unwanted movies.









### *In single-image mode*

- 1** Set the mode dial to .
- 2** Display the image you want to delete with  .
- 3** Press MENU.  
The menu appears.
- 4** Select [DELETE] with  , then press .
- 5** Select [OK] with , then press .
- 6** To continue and delete other images, display the image to be deleted with   and press . Then, select [OK] with  and press .

### To cancel deletion

Select [EXIT] in step **5** or **6**, then press .

### *In index (nine-image) mode*

- 1** Set the mode dial to , then press  to display an index (nine-image) screen.
- 2** Press MENU.  
The menu appears.
- 3** Select [DELETE] with  , then press .
- 4** Select [SELECT] with  , then press .
- 5** Select the image you want to delete with    , then press .

The green  (delete) indicator appears on the selected image.

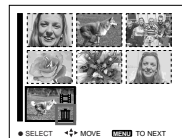

The image has not yet been deleted at this point.

- 6** Repeat step **5** to delete other images.
- 7** Press MENU.  
The menu appears.

**8** Select [OK] with **▶**, then press



When the message “MEMORY STICK ACCESS” disappears, the images have been deleted.

**To cancel deletion**

Select [EXIT] in step **8**.

**To delete all images in the folder**

Select [ALL IN FOLDER] in step **4**,

[OK] with **▶**, then press ●. To cancel deletion, select [EXIT] with **◀**, then press



*In index (triple-image) mode*

**1** Set the mode dial to **▶**, then press **⏏** twice to display an index (triple-image) screen.

**2** Display the image you want to delete in the center position with **◀/▶**.

**3** Press MENU.

The menu appears.

**4** Select [DELETE] with **▲/▼**, then press ●.

The image has not yet been deleted at this point.

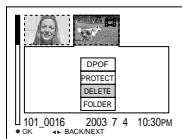

**5** Select [OK] with **▲**, then press



“MEMORY STICK ACCESS” appears on the screen. When the message disappears, the middle-positioned image has been deleted.

**To cancel deletion**

Select [CANCEL] in step **5**, then press ●.



## 5 Decide on a cutting point.

Press the center **●** at the desired cutting point.

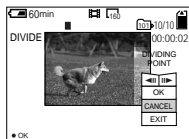

When you want to adjust the cutting point, use [**◀|||/||▶**] (frame forward/rewind) and adjust the cutting point using **◀/▶**. If you want to change the cutting point, select [CANCEL]. The playback of the movie starts again.

## 6 When you have decided on a cutting point, select [OK] with **▲/▼**, and press **●**.

## 7 Select [OK] with **▲**, then press **●**.

The movie is cut.

The recording folder appears at the upper right of the screen.

## To cancel cutting

In Step **5**, select [EXIT]. The movie appears on the screen again.

- The cut movie are recorded as the newest files in the selected recording folder.
- You cannot cut the following files.
  - Clip Motion files
  - Multi Burst files
  - Still image files
  - MPEG movie files not long enough to cut
  - Protected MPEG movie files
- You cannot restore files once you cut them.
- The original file is deleted when you cut it.

## *Deleting unnecessary portions of movies*

### 1 Cut an unnecessary portion of a movie (page 79).

### 2 Display the portion of the movie you want to delete.

### 3 Press MENU.

The menu appears.

### 4 Select [DELETE] with **◀/▶**, then press **●**.

### 5 Select [OK] with **▲**, then press **●**.

The movie currently displayed on the screen is deleted.



## Copying images to your computer

### — For Windows users

#### Recommended computer environment

**OS:** Microsoft Windows 98, Windows 98SE, Windows 2000 Professional, Windows Millennium Edition, Windows XP Home Edition, or Windows XP Professional

The above OS must be installed at the factory. Operation is not assured in an environment upgraded to the operating systems described above or in a multi-boot environment.

**CPU:** MMX Pentium 200 MHz or faster

**USB connector:** Provided as standard

**Display:** 800 × 600 dots or more

High Color (16-bit color, 65,000 colors) or more

- If you connect two or more USB equipment to a single computer at the same time, some equipment, including your camera, may not operate depending on the type of USB equipment.
- Operations are not guaranteed when using a USB hub.
- Operations are not guaranteed for all the recommended computer environments mentioned above.

- This camera is compatible with USB 2.0. The USB 2.0 interface is completely compatible with USB 1.1, so USB 1.1 equipment can also be used.
- Use with a USB 2.0 (High Speed) compatible computer environment allows high-speed data transfer (approximately 1.5 times faster than the conventional Sony model DSC-F707).

#### USB mode

There are two modes for a USB connection, [NORMAL] and [PTP]\* modes. The factory setting is the [NORMAL] mode.

\* Compatible only with Windows XP. When connected to a computer, only the data in the folder selected by the camera is copied to the computer. To select a folder, perform the procedure from step 2 on page 66.

#### Communication with your computer

When your computer resumes from the suspend or sleep mode, communication between your camera and your computer may not recover at the same time.

#### When a USB connector is not provided on your computer

When neither a USB connector nor a “Memory Stick” slot is provided, you can copy images using an additional device. See the Sony Website for details.  
<http://www.sony.net/>

#### Contents of the CD-ROM

##### ■ USB Driver

This driver is needed in order to connect the camera to a computer.

- When using Windows XP, you need not install the USB driver.

##### ■ Image Transfer

This application is used to easily transfer images from the camera to a computer.

##### ■ PIXELA ImageMixer

This application is used to display and edit images that are stored in a computer.

- This section describes the Windows Me screen as an example. The required operations may differ depending on your OS.
- **Close down all applications running on the computer before installing the USB driver and application.**
- When using Windows XP or Windows 2000, log on as Administrators.
- The display settings should be 800 × 600 dots or more and High Color (16-bit color, 65,000 colors) or more. When set to less than 800 × 600 dots or 256 colors or less, the install title screen does not appear.

## Installing the USB driver

- When using Windows XP, you need not install the USB driver.
- Once the USB driver is installed, you need not install the USB driver.

- 1 Start up your computer, and insert the supplied CD-ROM into the CD-ROM drive.**

**Do not connect your camera to your computer at this time.**

The title screen appears. If it does not appear, double-click  (My Computer) → [ImageMixer] in that order.

- 2 Click [USB Driver] on the title screen.**



The “InstallShield Wizard” screen appears.

- 3 Click [Next]. When the “Information” screen appears, click [Next].**



The USB driver installation starts. When the installation is completed, the screen informs you of completion.

- 4 Click [Yes, I want to restart my computer now], then click [Finish].**

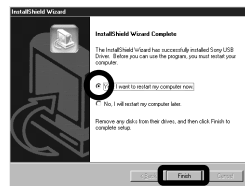

Your computer restarts.

## Installing “Image Transfer”

- You can use the “Image Transfer” software to copy images to your computer automatically when you connect the camera to your computer with the supplied USB cable.

- 1 Click [Image Transfer] on the title screen. Select the desired language, then click [OK].**

The “Welcome to the InstallShield Wizard” screen appears.



- This section describes the English screen.

- 2** Click [Next]. When “Licence Agreement” screen appears, click [Yes].



Read the agreement carefully. You must accept the terms of the agreement in order to proceed with installation.

- 3** Click [Next].

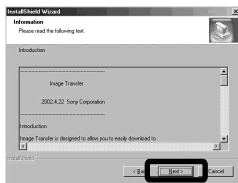

- 4** Select the folder to be installed, then click [Next]. Select the program folder, then click [Next].

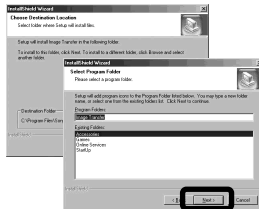

- 5** Confirm if the checkbox is checked on the “Image Transfer Settings” screen, then click [Next].

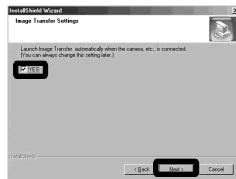

When the installation is completed, the screen informs you of completion.

- 6** Click [Finish].



The “InstallShield Wizard” screen closes.

- The USB driver is needed in order to use “Image Transfer”. If the necessary driver is not already installed on your computer, a screen that asks if you want to install the driver will appear. Follow the instructions that appear on the screen.

## Installing "ImageMixer"

- 1 Click [PIXELA ImageMixer] on the title screen.**



The "Choose Setup Language" screen appears.

- You can use the "PIXELA ImageMixer for Sony" software to copy, view and edit images. For details, see the software's help files.

- 2 Select the desired language, then click [OK].**



The "Welcome to the InstallShield Wizard" screen appears.

- This section describes the English screen.

- 3 Follow instructions on each succeeding screen.**

When installation is complete, the "Read Me" text appears. Read the text, then close the window by clicking  in the upper right corner of the screen. After that, click [Finish] on the install screen to close the install screen.

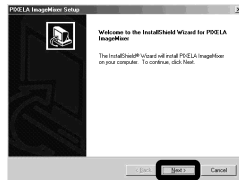

- If DirectX8.0a or a later version is not installed in your computer, the "Information" screen appears. Follow the procedure on the screen.

- 4 Remove the CD-ROM.**

*Connecting your camera to your computer*

- 1 Insert the "Memory Stick" with the images you want to copy into the camera.**
- 2 Turn on your camera and computer.**  
Set [USB CONNECT] to [NORMAL] in the SET UP settings. The factory setting is [NORMAL].
- 3 Open the jack cover, and connect the supplied USB cable to your camera.**

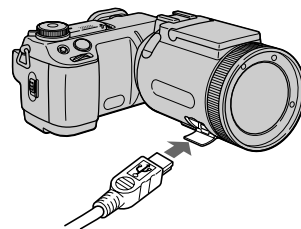

#### 4 Connect the other end of the USB cable to your computer.

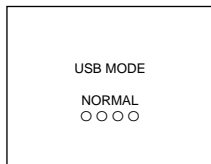

“USB MODE NORMAL” appears on the screen. When a USB connection is established for the first time, your computer automatically runs the used program to recognize your camera. Wait for a while, and “Image Transfer” launches.



- When using a desktop computer, connect the USB cable to the USB connector on the rear panel.
- When using Windows XP, the copy wizard automatically appears on the desktop (page 87). When you copy images using “Image Transfer”, change the settings on page 86.

### Disconnecting the USB cable from your computer, removing the “Memory Stick” from your camera or turning off the power during USB connection

#### For Windows 2000, Me, or XP users

- 1 Double-click  on the tasktray.
- 2 Click , then click [Stop].
- 3 Confirm the device on the confirmation screen, then click [OK].
- 4 Click [OK].  
This step is unnecessary for Windows XP users.
- 5 Disconnect the USB cable, remove the “Memory Stick” or turn off the power.

#### For Windows 98 or 98SE users

Perform only step 5 above.

### Copying images using “Image Transfer”

#### — Windows 98/98SE/2000/Me

When you connect the camera to your computer, “Image Transfer” launches and the images are automatically copied to the computer. When copying is complete, “ImageMixer” automatically launches and images appears.

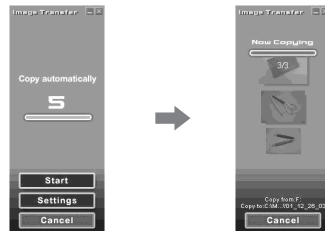

- Normally “Image Transfer” and “Date” folders are created inside the “My Documents” folder, and all of the image files recorded with your camera are copied into these folders.
- You can change the “Image Transfer” settings (page 86).
- When you use Windows XP, you need to change the settings (page 86).

## — Windows XP

Windows XP is set so that the OS AutoPlay Wizard activates. Follow the procedure below to cancel the setting.

- This procedure does not need to be performed for subsequent image downloads.

**1 Click [Start], then click [My Computer].**

**2 Right-click [Sony MemoryStick], then click [Properties].**

**3 Cancel the setting.**

- ① Click [AutoPlay].
- ② Set [Content type] to [Pictures].
- ③ Check [Select an action to perform] under [Actions], select [Take no action], then click [Apply].
- ④ Set [Content type] to [Video files] and [Mixed content] in step ②, and repeat step ③.
- ⑤ Click [OK].

The [Properties] screen closes.

**4 Disconnect and then reconnect the USB cable (page 85).**

## Changing “Image Transfer” settings

You can change the “Image Transfer” settings.

Right-click the “Image Transfer” icon in the tasktray and select [Open Settings], or select [Settings] when starting up “Image Transfer”.

- You can set [Basic], [Copy] and [Delete].
- If you select [Settings] when starting up “Image Transfer”, you can only change [Basic].
- To return to the standard settings, click [Restore defaults].

## *Copying images without using “Image Transfer”*

### — Windows 98/98SE/2000/Me

If you do not set to launch “Image Transfer” automatically, you can copy images as following procedure.

**1 Double-click [My Computer], then double-click [Removable Disk].**

The contents of the “Memory Stick” inserted in your camera appear.

- This section describes an example of copying images to the “My Documents” folder.
- When the “Removable Disk” icon is not shown, see the following column.
- When using Windows XP, see the previous column.

**2 Double-click [DCIM], then double-click the folder which contains the desired images.**

The folder opens.

**3 Drag and drop the image files into the “My Documents” folder.**

The image files are copied to the “My Documents” folder.

- When you try to copy an image to a folder in which an image with the same file name is stored, the overwrite confirmation message appears. When you overwrite the existing image with the new one, the original file is deleted.

## When a removable disk icon is not shown

- 1 Right-click [My Computer], then click [Properties].  
The “System Properties” screen appears.
- When using Windows 2000, click [Hardware] on [System Properties] screen.
- 2 Confirm if other devices are already installed.
  - ① Click [Device Manager].
  - ② Double-click [ Other Devices].
  - ③ Confirm if there is a “ Sony DSC” or “ Sony Handycam” with a mark.
- 3 If you find either of the devices above, follow the steps below to delete them.
  - ① Click [ Sony DSC] or [ Sony Handycam].
  - ② Click [Remove].  
The “Confirm Device Removal” screen appears.
  - ③ Click [OK].  
The device is deleted.
- 4 Try the USB driver installation again using the supplied CD-ROM (page 82).

## — Windows XP

### Copying images using the Windows XP copy wizard

- 1 Click [Copy pictures to a folder on my computer using Microsoft Scanner and Camera Wizard], then click [OK].

The “Scanner and Camera Wizard” screen appears.

- 2 Click [Next].

The images stored on the “Memory Stick” are displayed.

- 3 Click the checkbox of images that you do not want to copy to your computer and remove the checkmark, then click [Next].

The “Picture Name and Destination” screen appears.

- 4 Specify the image group names to be copied and the copy destination, then click [Next].

Image copying starts. When the copying is completed, the “Other Options” screen appears.

- The images are copied into the “My Documents” folder.

- 5 Select [Nothing. I’m finished working with these pictures], then click [Next].

The “Completing the Scanner and Camera Wizard” screen appears.

- 6 Click [Finish].

The wizard closes.

- To continue copying other images, disconnect the USB cable and reconnect it. Then, perform the procedure from step 1 again.

## Viewing images on your computer

### 1 Double-click [My Documents] on the desktop.

The “My Documents” folder contents are displayed.

- This section describes the procedure for copying images to the “My Documents” folder.
- When using Windows XP, double-click [Start] → [My Documents] in that order.
- You can use the “PIXELA ImageMixer for Sony” software to view and edit images on your computer. For details, see the software’s help files.

### 2 Double-click the desired folder and image file.

The image is displayed.

## Image file storage destinations and file names

Image files recorded with your camera are grouped as folders in the “Memory Stick” by recording modes.

### Example: For Windows Me users

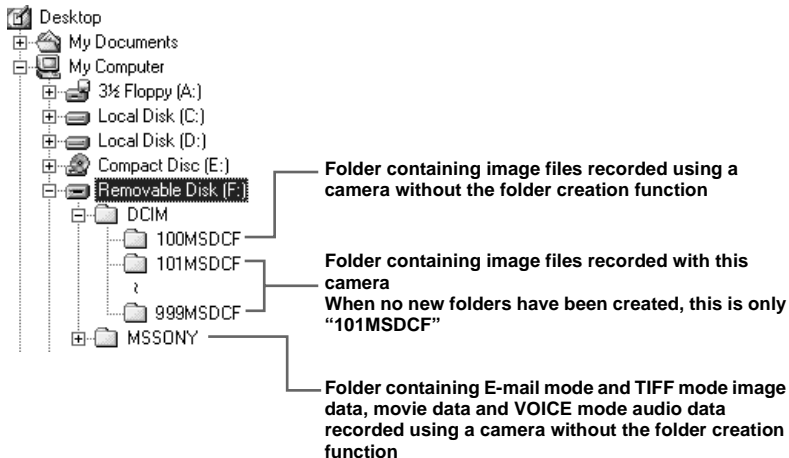

- Data in the “100MSDCF” or “MSSONY” folders is data recorded using a camera without the folder creation function. These folders are for playback only, and your camera cannot record images in these folders.



Folder	File name	File meaning
101MSDCF (up to 999MSDCF)	DSC0□□□□.JPG	<ul style="list-style-type: none"> <li>• Still image files shot in               <ul style="list-style-type: none"> <li>– Normal mode</li> <li>– Exposure Bracket mode (page 53)</li> <li>– BURST 3 mode (page 59)</li> <li>– Multi Burst mode (page 58)</li> </ul> </li> <li>• Still image files recorded simultaneously in               <ul style="list-style-type: none"> <li>– TIFF mode (page 60)</li> <li>– E-MAIL mode (page 61)</li> <li>– VOICE mode (page 61)</li> </ul> </li> </ul>
	DSC0□□□□.JPE	• Small-size image files shot in E-MAIL mode (page 61)
	DSC0□□□□.MPG	• Audio files shot in VOICE mode (page 61)
	DSC0□□□□.TIF	• Uncompressed image file recorded in TIFF mode (page 60)
	CLP0□□□□.GIF	• Clip Motion files shot in NORMAL mode (page 57)
	CLP0□□□□.THM	• Index image files of Clip Motion files shot in NORMAL mode
	MBL0□□□□.GIF	• Clip Motion files shot in MOBILE mode (page 57)
	MBL0□□□□.THM	• Index image files of Clip Motion files shot in MOBILE mode
MOV0□□□□.MPG	• Movie files shot normally (page 75)	

#### Note on the table

- The meanings of the file names are as above:  
□□□□ stands for any number within the range from 0001 to 9999.
- The numerical portions of the following files are the same.
  - A small-size image file shot in E-MAIL mode and its corresponding image file
  - An audio file shot in VOICE mode and its corresponding image file
  - An uncompressed image file shot in TIFF mode and its corresponding image file
  - An image file shot with Clip Motion and its corresponding index image file

## Copying images to your computer

### — For Macintosh users

#### Recommended computer environment

**OS:** Mac OS 8.5.1, 8.6, 9.0, 9.1, 9.2, or Mac OS X (v10.0/v10.1)

The above OS must be installed at the factory. For the following models, update your OS to Mac OS 9.0 or 9.1.

- iMac with Mac OS 8.6 installed at the factory, and a slot loading type CD-ROM drive
- iBook or Power Mac G4 with the Mac OS 8.6 installed at the factory

**USB connector:** Provided as standard

**Display:** 800 × 600 dots or more  
32,000-color mode or more

- If you connect two or more USB equipment to a single computer at the same time, some equipment, including your camera, may not operate depending on the type of USB equipment.
- Operations are not guaranteed when using a USB hub.
- Operations are not guaranteed for all the recommended computer environments mentioned above.

#### USB mode

There are two modes for a USB connection, [NORMAL] and [PTP]\* modes. The factory setting is the [NORMAL] mode.

\* Compatible only with Mac OS X. When connected to a computer, only the data in the folder selected by the camera is copied to the computer. To select a folder, perform the procedure from step **2** on page 66.

#### Communication with your computer

When your computer resumes from the suspend or sleep mode, communication between your camera and your computer may not recover at the same time.

#### When a USB connector is not provided on your computer

When neither a USB connector nor a “Memory Stick” slot is provided, you can copy images using an additional device. See the Sony Website for details.



<http://www.sony.net/>

#### Steps requires your OS

Follow the steps below, according to your OS.

OS	Steps
Mac OS 8.5.1/8.6/9.0	Steps <b>1</b> to <b>4</b>
Mac OS 9.1/9.2/Mac OS X (v10.0/v10.1)	Steps <b>2</b> to <b>4</b>

#### **1** Installing the USB driver

- 1 Turn on your computer, and set the supplied CD-ROM into the CD-ROM drive.  
The “PIXELA ImageMixer for Sony” screen appears.
- 2 Double-click  (Setup Menu).
- 3 Click  (USB Driver).  
The “USB Driver” screen appears.
- 4 Double-click the icon of the hard disk containing the OS to open the screen.
- 5 Drag and drop the following two files from the screen opened in step 3 into the System Folder icon in the screen opened in step 4.
  - Sony USB Driver
  - Sony USB Shim
- 6 When the message for confirmation is shown, click “OK.”
- 7 Restart your computer, then remove the CD-ROM.

#### **2** Connecting your camera to your computer

For details, see page 84.

### Removing the USB cable from your computer, the “Memory Stick” from your camera or turning off the power during a USB connection

Drag and drop the “Memory Stick” icon to the “Trash” icon, then remove the USB cable or “Memory Stick” or turn off the power.

\* If you are using Mac OS X, remove the USB cable, etc., after you have turned your computer off.

### 3 Copying images

- 1 Double-click the newly recognized icon on the desktop.  
The contents of the “Memory Stick” inserted in your camera appear.
- 2 Double-click “DCIM.”
- 3 Double-click the folder contained the desired image file.
  - See pages 88 and 89 for details about the image file storage destinations and file names.
- 4 Drag and drop the image files to the hard disk icon.  
The image files are copied to your hard disk.

### 4 Viewing the images on your computer

- 1 Double-click the hard disk icon.
- 2 Double-click the desired image file in the folder containing the copied files.  
The image file opens.
  - You can use the “PIXELA ImageMixer” software to copy images to your computer and to view images on your computer. See the operation manual supplied with the CD-ROM for details about the installation method, or see the software’s help files for the operation method.
  - “PIXELA ImageMixer” is not compatible with Mac OS X.

### For Mac OS X users

If the “There is no application available to open the document “DSC0□□□□.JPE”.” screen appears when you click an E-mail mode image file, make the following setting.

- The screen display may differ depending on the version.
- 1 Click [Choose Application...] at the “There is no application available to open the document “DSC0□□□□.JPE”.” screen.
  - 2 Change “Show” from [Recommended Applications] to [All Applications].
  - 3 Select [QuickTime Player] from the displayed list of applications, and click [Open].

## Troubleshooting

If you experience trouble with your camera, try the following solutions.

- 1 First check the items on the tables below.  
**If code displays “C:□□:□□” appear on the screen, the self-diagnosis display function is working (page 103).**

- 2 Should your camera still not work properly, press the RESET button inside the battery/“Memory Stick” cover using a fine-tripped object, then turn on the power again. (All the settings including date and time are cleared.)

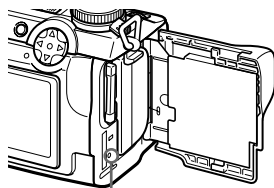

RESET button

- 3 Should your camera still not work properly, consult your Sony dealer or local authorized Sony service facility.





### Battery pack and power







Symptom	Cause	Solution
You cannot charge the battery pack.	<ul style="list-style-type: none"><li>• The camera is turned on.</li></ul>	→ Turn the camera off (page 15).
The battery pack cannot be installed.	<ul style="list-style-type: none"><li>• The battery pack is not installed correctly.</li></ul>	→ Install the battery pack while pushing the battery eject lever up using the front edge of the battery pack (page 11).
The $\frac{1}{2}$ /CHG lamp flashes.	<ul style="list-style-type: none"><li>• The battery pack is not installed correctly.</li><li>• The battery pack has malfunctioned.</li></ul>	→ Install the battery pack correctly (page 11). → Consult your Sony dealer or local authorized Sony service facility.
The $\frac{1}{2}$ /CHG lamp does not light up when charging a battery pack.	<ul style="list-style-type: none"><li>• The AC power adaptor is disconnected.</li><li>• The battery pack is not installed correctly.</li><li>• The battery pack is completely charged.</li></ul>	→ Properly connect the AC power adaptor (page 12). → Install the battery pack correctly (page 11). —

Symptom	Cause	Solution
<b>The battery remaining indicator is incorrect, or sufficient battery remaining indicator is displayed but the power runs out soon.</b>	<ul style="list-style-type: none"> <li>You have used the camera for a long time in an extremely hot or an extremely cold location.</li> <li>The battery pack is dead (page 115).</li> <li>The battery pack is discharged.</li> <li>A deviation has occurred in the remaining battery time.</li> </ul>	<p>—</p> <ul style="list-style-type: none"> <li>→ Replace the battery pack with a new one.</li> <li>→ Install a charged battery pack (page 11).</li> <li>→ Fully charge the battery pack (page 12).</li> </ul>
<b>The battery pack runs down too quickly.</b>	<ul style="list-style-type: none"> <li>You are shooting/viewing images in an extremely cold location.</li> <li>The battery pack is not charged enough.</li> <li>The battery pack is dead (page 115).</li> </ul>	<p>—</p> <ul style="list-style-type: none"> <li>→ Charge the battery pack (page 11).</li> <li>→ Replace the battery pack with a new one.</li> </ul>
<b>You cannot turn on the camera.</b>	<ul style="list-style-type: none"> <li>The battery pack is not installed correctly.</li> <li>The AC power adaptor is disconnected.</li> </ul>	<ul style="list-style-type: none"> <li>→ Install the battery pack correctly (page 11).</li> <li>→ Properly connect the AC power adaptor (page 14).</li> </ul>
<b>The power turns off suddenly.</b>	<ul style="list-style-type: none"> <li>If you do not operate the camera for about three minutes when using a battery pack, the camera turns off automatically to prevent wearing down the battery (page 15).</li> <li>The battery pack is discharged.</li> </ul>	<ul style="list-style-type: none"> <li>→ Turn on the camera again (page 15).</li> <li>→ Replace it with a charged battery pack (page 11).</li> </ul>

## Shooting still images/movies



Symptom	Cause	Solution
<b>The subject does not appear on the screen.</b>	<ul style="list-style-type: none"> <li>The FINDER/LCD switch is set to FINDER.</li> </ul>	→ Set it to LCD (page 22).
<b>The subject is not visible on the screen.</b>	<ul style="list-style-type: none"> <li>The mode dial is set to  or SET UP.</li> </ul>	→ Set it to other modes (pages 20 and 75).
<b>The image is out of focus.</b>	<ul style="list-style-type: none"> <li>The subject is too close.</li> <li>The Landscape mode is selected for the Scene Selection function.</li> <li>Manual focus mode is selected.</li> <li>[CONVERSION LENS] in the SET UP settings is set to [ON].</li> </ul>	→ Record in the macro recording mode. Make sure to position the lens farther away from the subject than the shortest shooting distance when shooting (page 24). → Set it to other modes (page 29).  → Set the FOCUS switch to AUTO/ZOOM (pages 23 and 48). → Set it to [OFF] (pages 42 and 110).
<b>Zoom does not work.</b>	<ul style="list-style-type: none"> <li>[CONVERSION LENS] in the SET UP settings is set to [ON].</li> <li>FOCUS switch is set to MANUAL.</li> </ul>	→ Set it to [OFF] (pages 42 and 110).  → Set the FOCUS switch to AUTO/ZOOM (page 23).
<b>Digital zoom does not function.</b>	<ul style="list-style-type: none"> <li>The digital zoom cannot be used when shooting a movie (MPEG MOVIE).</li> <li>[DIGITAL ZOOM] in the SET UP settings is set to [OFF].</li> </ul>	—  → Set it to [ON] (pages 42 and 110).
<b>The image is too dark.</b>	<ul style="list-style-type: none"> <li>You are shooting a subject with a light source behind the subject.</li> <li>The brightness of the screen is too low.</li> </ul>	→ Adjust the exposure (page 49).  → Adjust the brightness of the screen (pages 42 and 112).
<b>The image is too bright.</b>	<ul style="list-style-type: none"> <li>You are shooting a spotlighted subject in a dark location such as on a stage.</li> <li>The brightness of the screen is too bright.</li> </ul>	→ Adjust the exposure (page 49).  → Adjust the brightness of the screen (pages 42 and 112).
<b>Vertical streaks appear when you are shooting a very bright subject.</b>	<ul style="list-style-type: none"> <li>The smear phenomenon is occurring.</li> </ul>	→ This is not a malfunction.

Symptom	Cause	Solution
<b>Your camera cannot record images.</b>	<ul style="list-style-type: none"> <li>• No “Memory Stick” has been inserted.</li> <li>• The capacity of the “Memory Stick” is insufficient.</li> <li>• The write-protect switch on the “Memory Stick” is set to the LOCK position.</li> <li>• You cannot record images while charging the flash.</li> <li>• The mode dial is set to SET UP or .</li> </ul>	<p>→ Insert a “Memory Stick” (page 18).</p> <p>→ Delete the images saved in the “Memory Stick” (pages 37 and 77), or format it (page 40).</p> <p>→ Set it to the recording position (page 114).</p> <p>—</p> <p>→ Set it to other modes.</p>
<b>Recording takes a long time.</b>	<ul style="list-style-type: none"> <li>• NR slow shutter is activated.</li> </ul>	<p>→ Set to a faster shutter speed than 1/25 second (page 44).</p>
<b>A sound is made if the NIGHTSHOT/NIGHTFRAMING switch is changed.</b>	<ul style="list-style-type: none"> <li>• The sound is made by the lens in operation.</li> </ul>	—
<b>The image colors are not correct.</b>	<ul style="list-style-type: none"> <li>• NIGHTSHOT or NIGHTFRAMING is set.</li> </ul>	<p>→ Set to .</p>
<b>The lens makes a noise inside if the shutter button is lightly pressed while NIGHTFRAMING is set.</b>	<ul style="list-style-type: none"> <li>• The sound is made by the AE/AF function in operation.</li> </ul>	<p>→ This is not a malfunction.</p>
<b>NightShot or NightFraming does not function.</b>	<ul style="list-style-type: none"> <li>• The mode dial is set to S, A, M or SCN.</li> </ul>	<p>→ Set it to ,  or  (NightFraming for Clip Motion) (page 55).</p>

Symptom	Cause	Solution
<b>The built-in flash or the optional external flash (HVL-F1000) does not work.</b>	<ul style="list-style-type: none"> <li>• The mode dial is set to , SET UP, or  (MPEG MOVIE or MULTI BURST).</li> <li>• The flash is set to  (no flash).</li> <li>• The Twilight mode is selected for the Scene Selection function.</li> <li>• The Landscape mode is selected for the Scene Selection function.</li> <li>• [MODE] (REC MODE) in the menu settings is set to [BURST 3] or [EXP BRKTG].</li> <li>• [HOT SHOE] in the SET UP settings is set to [ON].</li> <li>• NightShot is activated.</li> </ul>	<p>→ Set it to other modes.</p> <p>→ Set the flash to auto (no indicator) or  (forced flash) (page 26). → Cancel the setting (page 29).</p> <p>→ Set the flash to  (forced flash) (page 26).</p> <p>→ Set it to other settings.</p> <p>→ Set it to [OFF] (pages 42 and 111).</p> <p>→ Set NIGHTSHOT/NIGHTFRAMING to  or NIGHTFRAMING.</p>
<b>The macro function does not work.</b>	<ul style="list-style-type: none"> <li>• The Landscape mode is selected for the Scene Selection function.</li> <li>• [CONVERSION LENS] in the SET UP settings is set to [ON].</li> </ul>	<p>→ Cancel the setting (page 29).</p> <p>→ Set it to [OFF] (pages 42 and 110).</p>
<b>The eyes of the subject come out red.</b>	—	→ Set [RED EYE REDUCTION] in the SET UP settings to [ON] (page 26).
<b>The date and time are recorded incorrectly.</b>	<ul style="list-style-type: none"> <li>• The date and time are not set correctly.</li> </ul>	→ Set the correct date and time (page 16).



## Viewing images

Symptom	Cause	Solution
<b>Your camera cannot play back images.</b>	<ul style="list-style-type: none"> <li>The mode dial is not set to .</li> <li>Your camera cannot play back image files copied to the hard disk of your computer if the file name has been changed or the image has been modified.</li> </ul>	→ Set it to  (page 33). —
<b>The image appears rough right after playback starts.</b>	—	→ This is not a malfunction.
<b>The image does not appear on the TV screen.</b>	<ul style="list-style-type: none"> <li>The video output signal setting of your camera in the SET UP settings is incorrect.</li> <li>The connection is not correct.</li> </ul>	→ Change the setting (pages 42 and 112). → Check the connection (page 35).
<b>The image cannot be played back on a computer.</b>	—	→ See page 98.
<b>Unknown beeps are heard from the camera while viewing a movie.</b>	<ul style="list-style-type: none"> <li>These beeps are heard when the auto focus is working.</li> </ul>	→ This is not a malfunction. Set FOCUS switch to MANUAL (page 48).
<b>The picture is noisy.</b>	<ul style="list-style-type: none"> <li>Your camera is placed near a TV or other equipment with a strong magnetic field.</li> </ul>	→ Move your camera away from the TV, etc.

## Deleting/Editing Images

Symptom	Cause	Solution
<b>Your camera cannot delete an image.</b>	<ul style="list-style-type: none"> <li>The image is protected.</li> <li>The write-protect switch on the “Memory Stick” is set to the LOCK position.</li> </ul>	→ Cancel the protection (page 70). → Set it to the recording position (page 114).
<b>You have deleted an image by mistake.</b>	<ul style="list-style-type: none"> <li>Once you have deleted a file, you cannot restore it.</li> </ul>	→ Marking  (protect) will prevent you from deleting images by mistake (page 70).
<b>The resizing function does not work.</b>	<ul style="list-style-type: none"> <li>You cannot resize movies (MPEG MOVIE), Clip Motion, Multi Burst and uncompressed images.</li> </ul>	—

Symptom	Cause	Solution
<b>You cannot display a print (DPOF) mark.</b>	<ul style="list-style-type: none"> <li>You cannot display print (DPOF) marks on moving images and Clip Motion images.</li> </ul>	—

## Computers

Symptom	Cause	Solution
<b>You do not know if the OS of your computer is compatible.</b>	—	→ Check “Recommended computer environment” (pages 81 and 90).
<b>You cannot install the USB driver.</b>	—	→ In Windows 2000, log on as Administrator (authorized Administrators) (page 81).
<b>Your computer does not recognize your camera.</b>	<ul style="list-style-type: none"> <li>The camera is turned off.</li> <li>The battery level is low.</li> <li>You are not using the supplied USB cable.</li> <li>The USB cable is not connected firmly.</li> <li>[USB CONNECT] is set to [PTP] in the SET UP settings (except Windows XP and Mac OS X).</li> <li>The USB connectors on your computer are connected to other equipment besides the keyboard, the mouse, and your camera.</li> <li>The USB driver is not installed.</li> </ul>	<ul style="list-style-type: none"> <li>→ Turn on the camera (page 15).</li> <li>→ Use the AC power adaptor (page 14).</li> <li>→ Use the supplied USB cable (page 84).</li> <li>→ Disconnect the USB cable, and connect it again firmly. Make sure that “USB MODE” is displayed on the screen (page 84).</li> <li>→ Set it to [NORMAL] (page 112).</li> <li>→ Disconnect the USB cables except for the ones connected to the keyboard, the mouse, and your camera.</li> <li>→ Install the USB driver (pages 82 and 90).</li> </ul>
<b>You cannot copy images.</b>	<ul style="list-style-type: none"> <li>The camera is not correctly connected to your computer.</li> <li>You are not using the correct copy procedure for your OS.</li> </ul>	<ul style="list-style-type: none"> <li>→ Connect the camera and your computer correctly using the USB cable (page 84).</li> <li>→ Follow the designated copy procedure for your OS (pages 85, 86 and 91).</li> <li>→ If you are using the “PIXELA ImageMixer for Sony” application software, click on HELP.</li> </ul>
<b>The image cannot be played back on a computer.</b>	—	<ul style="list-style-type: none"> <li>→ If you are using the “PIXELA ImageMixer for Sony” application software, click on HELP.</li> <li>→ Consult the computer or software manufacturer.</li> </ul>

Symptom	Cause	Solution
<b>The image and sound are interrupted by noise when you view a movie on a computer.</b>	<ul style="list-style-type: none"> <li>You are playing back the file directly from the “Memory Stick”.</li> </ul>	→ Copy the file to the hard disk of your computer and then play back the file from the hard disk (pages 85, 86 and 91).
<b>You cannot print an image.</b>	— —	→ Check the printer settings. → Click on the HELP for the “PIXELA ImageMixer for Sony” application software.
<b>An error message appears when you set the supplied CD-ROM in your computer.</b>	<ul style="list-style-type: none"> <li>The computer display is not set correctly.</li> </ul>	→ Set the computer display as follows: Windows: 800 × 600 dots or more High Color (16 bits, 65,000 colors) or more Macintosh: 800 × 600 dots or more 32,000-color or more

## “Memory Stick”

Symptom	Cause	Solution
<b>You cannot insert a “Memory Stick.”</b>	<ul style="list-style-type: none"> <li>You are inserting it backwards.</li> </ul>	→ Insert it from the right side (page 18).
<b>You cannot record on a “Memory Stick.”</b>	<ul style="list-style-type: none"> <li>The write-protect switch on the “Memory Stick” is set to the LOCK position.</li> <li>The “Memory Stick” is full.</li> </ul>	→ Set it to the recording position (page 114). → Delete unnecessary images (page 37).
<b>You cannot format a “Memory Stick.”</b>	<ul style="list-style-type: none"> <li>The write-protect switch on the “Memory Stick” is set to the LOCK position.</li> </ul>	→ Set it to the recording position (page 114).
<b>You have formatted a “Memory Stick” by mistake.</b>	<ul style="list-style-type: none"> <li>All the images on the “Memory Stick” are deleted by formatting. You cannot restore them.</li> </ul>	→ We recommend that you set the “Memory Stick” write-protect switch to the LOCK position to prevent accidental erasure (page 114).









## Others

Symptom	Cause	Solution
<b>Your camera does not work.</b>	<ul style="list-style-type: none"> <li>You are not using an “InfoLITHIUM” battery pack.</li> <li>The battery level is low. (The  indicator appears.)</li> <li>The AC power adaptor is not connected securely.</li> <li>The built-in microcomputer is not working properly.</li> </ul>	<p>→ Use an “InfoLITHIUM” battery pack (page 11).</p> <p>→ Charge the battery pack (page 11).</p> <p>→ Connect it securely to the DC IN jack of your camera and to a wall outlet (wall socket) (page 14).</p> <p>→ Turn the power off and then on after one minute, and check that the camera works properly.</p>
<b>The power is on, but the camera does not work.</b>	<ul style="list-style-type: none"> <li>The built-in microcomputer is not working properly.</li> </ul>	<p>→ Remove the battery pack, then install it again after about one minute and turn on the camera. If the functions still do not work, press the RESET button located inside the battery/“Memory Stick” cover with a fine-tipped object, then turn the power on again. (When you press the RESET button, all settings including the date and time are cleared.)</p>
<b>You cannot identify an indicator on the screen.</b>	—	→ Check the indicator (page 118).
<b>The lens gets fogged.</b>	<ul style="list-style-type: none"> <li>Moisture condensation has occurred.</li> </ul>	→ Turn off the camera and leave for about an hour at room temperature for the moisture to evaporate before use (page 113).
<b>The played back image is small.</b>	<ul style="list-style-type: none"> <li>You are playing back a file with an image size larger than 2560×1920 that was recorded using another camera.</li> </ul>	—
<b>The camera becomes warm when you use it for the long time.</b>	—	→ This is not a malfunction.

## Warnings and messages

The following messages may appear on the screen.

Message	Meaning/Corrective Action
<b>NO MEMORY STICK</b>	<ul style="list-style-type: none"><li>• Insert a “Memory Stick” (page 18).</li></ul>
<b>SYSTEM ERROR</b>	<ul style="list-style-type: none"><li>• Turn the power off and on again (page 15).</li></ul>
<b>MEMORY STICK ERROR</b>	<ul style="list-style-type: none"><li>• The inserted “Memory Stick” cannot be used in your camera (page 114).</li><li>• The “Memory Stick” is damaged, or the terminal section of the “Memory Stick” is dirty.</li><li>• Insert the “Memory Stick” correctly (page 18).</li></ul>
<b>MEMORY STICK TYPE ERROR</b>	<ul style="list-style-type: none"><li>• You inserted a “Memory Stick” that cannot be used with this camera (page 114).</li></ul>
<b>FORMAT ERROR</b>	<ul style="list-style-type: none"><li>• Failed to format the “Memory Stick.” Format the “Memory Stick” again (page 40).</li></ul>
<b>MEMORY STICK LOCKED</b>	<ul style="list-style-type: none"><li>• The write-protect switch on the “Memory Stick” is set to the LOCK position. Set it to the recording position (page 114).</li></ul>
<b>NO MEMORY SPACE</b>	<ul style="list-style-type: none"><li>• The capacity of the “Memory Stick” is insufficient. You cannot record images. Delete unnecessary images (page 37).</li></ul>
<b>CANNOT CREATE MORE FOLDERS</b>	<ul style="list-style-type: none"><li>• You have reached the maximum number of folders that can be created (page 64).</li></ul>
<b>CANNOT RECORD</b>	<ul style="list-style-type: none"><li>• The camera cannot record images in the selected folder. Select a different folder (page 65).</li></ul>
<b>NO FILE IN THIS FOLDER</b>	<ul style="list-style-type: none"><li>• No images have been recorded in this folder.</li><li>• You inserted a “Memory Stick” into your camera that was recorded using a camera without the folder creation function (page 66).</li></ul>
<b>FILE ERROR</b>	<ul style="list-style-type: none"><li>• An error occurred while playing back the image.</li></ul>
<b>FILE PROTECT</b>	<ul style="list-style-type: none"><li>• The image is protected against erasure.</li></ul>
<b>For "InfoLITHIUM" battery only</b>	<ul style="list-style-type: none"><li>• The battery is not the “InfoLITHIUM” type.</li></ul>
<b>FOLDER ERROR</b>	<ul style="list-style-type: none"><li>• A folder with the same number already exists in the “Memory Stick.”</li></ul>
<b>IMAGE SIZE OVER</b>	<ul style="list-style-type: none"><li>• You are playing back an image of a size that cannot be played back on your camera.</li></ul>
<b>INVALID OPERATION</b>	<ul style="list-style-type: none"><li>• You are playing back a file that was created on equipment other than this camera.</li></ul>

Message	Meaning/Corrective Action
	<ul style="list-style-type: none"> <li>The battery level is low or zero. Charge the battery (page 11). Depending on the conditions of use or the type of battery pack, the indicator may flash even though there are still 5 to 10 minutes of remaining battery time left.</li> </ul>
<b>CAN NOT DIVIDE</b>	<ul style="list-style-type: none"> <li>The file is not long enough to be divided.</li> <li>The file is not a movie (MPEG MOVIE).</li> </ul>
	<ul style="list-style-type: none"> <li>The amount of lights is not sufficient or the shutter speed is too slow.</li> <li>You are not holding the camera steady enough. Use the flash, mount the camera on a tripod, or otherwise secure the camera in place.</li> </ul>
<b>“NIGHT SHOT”</b>	<ul style="list-style-type: none"> <li>An operation that is not valid while NIGHTSHOT is set is attempted.</li> </ul>
<b>“NIGHT FRAMING”</b>	<ul style="list-style-type: none"> <li>An operation that is not valid while NIGHTFRAMING is set is attempted.</li> </ul>
<b>NIGHT SHOT IS INVALID</b>	<ul style="list-style-type: none"> <li>The mode dial is set to a position other than ,  or  while NIGHTSHOT is set.</li> <li>[CONVERSION LENS] in the SET UP settings is set to [ON].</li> </ul>
<b>NIGHT FRAMING IS INVALID</b>	<ul style="list-style-type: none"> <li>The mode dial is set to a position other than ,  or  (Clip Motion) while NIGHTFRAMING is set.</li> <li>[CONVERSION LENS] in the SET UP settings is set to [ON].</li> </ul>
<b>MANUAL FOCUS IS INVALID</b>	<ul style="list-style-type: none"> <li>The manual focus/zoom ring is turned while NIGHTFRAMING is set.</li> <li>The FOCUS switch is set to MANUAL when the mode dial is set to .</li> </ul>

## Self-diagnosis display

– If a code starting with an alphabet letter appears

Your camera has a self-diagnosis display. This function displays the camera condition on the screen with a combination of a letter and four numerical digits. If this occurs, check the following code chart and attempt the corresponding corrective actions. The last two digits (indicated by □□) will differ depending on the state of the camera.

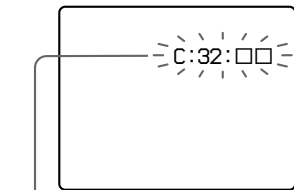

Self-diagnosis display

Code	Cause	Countermeasure
C:32: □□	There is trouble with your camera's hardware.	• Turn the power off and on again (page 15).
C:13: □□	The camera cannot read or write data on the "Memory Stick."	• Re-insert the "Memory Stick" several times.
	An unformatted "Memory Stick" is inserted.	• Format the "Memory Stick" (page 40).
	The inserted "Memory Stick" cannot be used with your camera, or the data is damaged.	• Insert a new "Memory Stick" (page 18).
E:61: □□ E:91: □□	A camera malfunction that you cannot reverse has occurred.	• Press the RESET button (page 9) located inside the battery/"Memory Stick" cover, then turn the power on again.

If you are unable to solve the problem even after trying the corrective actions a few times, contact your Sony dealer or local authorized Sony service facility and inform them of the 5-digit code.

Example: E:61:10

## Number of images that can be saved or shooting time

The number of images that can be saved and the shooting time differ, depending on the capacity of the “Memory Stick,” the image size, and the image quality. Refer to the following charts when you choose a “Memory Stick.”

- The number of images is listed in FINE (STANDARD) order.
- The values for the number of images that can be saved and the shooting time may vary, depending on the shooting conditions.
- For normal shooting times and numbers of images that can be saved, see page 32.
- When the number of remaining shooting images is greater than 9999, the >9999 indicator appears on the screen.

### E-mail

(Units: images)

	16MB	32MB	64MB	128MB	MSX-256	MSX-512	MSX-1G
2560×1920	6 (11)	12 (23)	25 (47)	51 (95)	91 (170)	186 (345)	380 (705)
2560 (3:2)	6 (11)	12 (23)	25 (47)	51 (95)	91 (170)	186 (345)	380 (705)
2048×1536	10 (18)	20 (36)	40 (73)	81 (146)	145 (255)	296 (518)	604 (1058)
1280×960	24 (44)	49 (89)	98 (179)	197 (359)	340 (595)	691 (1210)	1411 (2470)
640×480	88 (194)	178 (392)	358 (788)	718 (1580)	1190 (2381)	2420 (4841)	4940 (9881)

### TIFF

(Units: images)

	16MB	32MB	64MB	128MB	MSX-256	MSX-512	MSX-1G
2560×1920	0 (0)	1 (1)	3 (4)	7 (8)	13 (14)	27 (29)	56 (60)
2560 (3:2)	1 (1)	2 (2)	4 (4)	8 (8)	14 (16)	30 (32)	62 (67)
2048×1536	0 (1)	1 (2)	3 (4)	7 (8)	14 (14)	29 (30)	59 (62)
1280×960	1 (1)	2 (2)	4 (4)	8 (8)	15 (15)	30 (31)	62 (64)
640×480	1 (1)	2 (2)	4 (4)	8 (8)	15 (15)	31 (32)	65 (65)

### VOICE

(Units: images)

	16MB	32MB	64MB	128MB	MSX-256	MSX-512	MSX-1G
2560×1920	6 (11)	12 (22)	25 (45)	50 (91)	90 (166)	183 (337)	375 (689)
2560 (3:2)	6 (11)	12 (22)	25 (45)	50 (91)	90 (166)	183 (337)	375 (689)
2048×1536	9 (17)	19 (34)	39 (69)	79 (138)	142 (246)	290 (500)	592 (1022)
1280×960	22 (38)	45 (78)	91 (157)	183 (316)	324 (549)	660 (1117)	1347 (2280)
640×480	69 (121)	140 (245)	281 (492)	564 (987)	1020 (1785)	2074 (3630)	4234 (7410)



**Clip Motion**

(Units: images)

	<b>16MB</b>	<b>32MB</b>	<b>64MB</b>	<b>128MB</b>	<b>MSX-256</b>	<b>MSX-512</b>	<b>MSX-1G</b>
NORMAL	88	178	358	718	1190	2420	4940
MOBILE	486	982	1971	3951	3571	7261	14821

NORMAL: When ten frames are shot

MOBILE: When two frames are shot

**MPEG movies**

(Units: seconds)

	<b>16MB</b>	<b>32MB</b>	<b>64MB</b>	<b>128MB</b>	<b>MSX-256</b>	<b>MSX-512</b>	<b>MSX-1G</b>
320 (HQX)	42	87	176	354	641	1304	2663
320×240	174	352	708	1419	2567	5221	10657
160×112	673	1363	2740	5494	9935	20203	41239

**Multi Burst**

(Units: images)

	<b>16MB</b>	<b>32MB</b>	<b>64MB</b>	<b>128MB</b>	<b>MSX-256</b>	<b>MSX-512</b>	<b>MSX-1G</b>
1280×960	24 (46)	50 (93)	101 (187)	202 (376)	357 (649)	726 (1320)	1482 (2694)

## Menu items











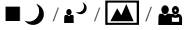

Menu items that can be modified differ depending on the position of the mode dial.

The screen shows only the items you can operate in each specific mode. Factory settings are indicated with ■.



### When the mode dial is set to

Item	Setting	Description
 (IMAGE SIZE)	■2560×1920 / 2560 (3:2) / 2048×1536 / 1280×960 / 640×480	Selects the image size when shooting still images (page 19).
MODE (REC MODE)	TIFF VOICE E-MAIL  EXP BRKTG  BURST 3 ■NORMAL	<ul style="list-style-type: none"><li>– Records a TIFF (uncompressed) file in addition to the JPEG file (page 60).</li><li>– Records an audio file (with a still image) in addition to the JPEG file (page 61).</li><li>– Records a small-size (320×240) JPEG file in addition to the selected image size (page 61).</li><li>– Records three images with the exposure value of each image slightly shifted (page 53).</li><li>– Records three images in succession (page 59).</li><li>– Records an image using the normal recording mode.</li></ul>









## When the mode dial is set to P, S, A, M, or SCN

Item	Setting	Description
<b>SCN</b>		Sets the Scene Selection mode (page 29). (This setting can be made only in SCN mode.)
<b>ISO</b>	800 / 400 / 200 / 100 /  AUTO	This selects the ISO sensitivity. Selecting a large number augments the brightness when recording in dark locations. However, note that increasing the sensitivity may make recorded images appear coarser. (This setting cannot be made in SCN mode.)
 <b>(IMAGE SIZE)</b>	 2560×1920 / 2560 (3:2) / 2048×1536 / 1280×960 / 640×480	Selects the image size when shooting still images (page 19).
 <b>(P.QUALITY)</b>	 FINE / STANDARD	Selects the image quality (page 31).
<b>MODE (REC MODE)</b>	TIFF VOICE E-MAIL  EXP BRKTG  BURST 3  NORMAL	<ul style="list-style-type: none"> <li>– Records a TIFF (uncompressed) file in addition to the JPEG file (page 60).</li> <li>– Records an audio file (with a still image) in addition to the JPEG file (page 61).</li> <li>– Records a small-size (320×240) JPEG file in addition to the selected image size (page 61).</li> <li>– Records three images with the exposure value of each image slightly shifted (page 53).</li> <li>– Records three images in succession (page 59).</li> <li>– Records an image using the normal recording mode.</li> </ul>
 <b>(FLASH LEVEL)</b>	HIGH  NORMAL LOW	<ul style="list-style-type: none"> <li>– Makes the flash level higher than normal.</li> <li>– Normal setting.</li> <li>– Makes the flash level lower than normal.</li> </ul>
<b>PFX (P.EFFECT)</b>	SOLARIZE / SEPIA / NEG.ART /  OFF	Sets the image special effects (page 62).
 <b>(SHARPNESS)</b>	+2 / +1 /  0 / -1 / -2	Adjusts the sharpness of the image. The  indicator appears (except when the setting is 0).









When the mode dial is set to  (when [MOVING IMAGE] is set to [MPEG MOVIE] in the SET UP settings)

Item	Setting	Description
 (IMAGE SIZE)	320(HQX) / 320×240 /  160×112	Selects the MPEG image size when shooting movies (page 75).
PFX (P.EFFECT)	SOLARIZE / SEPIA / NEG.ART /  OFF	Sets the image special effects (page 62).



When the mode dial is set to  (when [MOVING IMAGE] is set to [CLIP MOTION] in the SET UP settings)

Item	Setting	Description
 (IMAGE SIZE)	 NORMAL / MOBILE	Selects the Clip Motion image size (page 57).
 ± (FLASH LEVEL)	HIGH  NORMAL LOW	<ul style="list-style-type: none"> <li>– Makes the flash level higher than normal.</li> <li>– Normal setting.</li> <li>– Makes the flash level lower than normal.</li> </ul>
PFX (P.EFFECT)	SOLARIZE / SEPIA / NEG.ART /  OFF	Sets the image special effects (page 62).
 (SHARPNESS)	+2 / +1 /  0 / -1 / -2	Adjusts the sharpness of the image. The  indicator appears (except when the setting is 0).

When the mode dial is set to  (when [MOVING IMAGE] is set to [MULTI BURST] in the SET UP settings)

Item	Setting	Description
 (INTERVAL)	1/7.5 / 1/15 /  1/30 (NTSC) 1/6.3 / 1/12.5 /  1/25 (PAL)	<ul style="list-style-type: none"> <li>– Selects the Multi Burst shutter interval in NTSC mode.</li> <li>– Selects the Multi Burst shutter interval in PAL mode.</li> <li>* The shutter interval SETTINGS differ depending on the setting of the [VIDEO OUT] item in the SET UP settings (page 112).</li> </ul>
 (P.QUALITY)	 FINE / STANDARD	Selects the image quality (page 31).
PFX (P.EFFECT)	SOLARIZE / SEPIA / NEG.ART /  OFF	Sets the image special effects (page 62).
 (SHARPNESS)	+2 / +1 /  0 / -1 / -2	Adjusts the sharpness of the image. The  indicator appears (except when the setting is 0).

## When the mode dial is set to

Item	Setting	Description
<b>FOLDER</b>	OK / CANCEL	Selects the folder containing the image you want to play back (page 66).
<b>DELETE</b>	—	Deletes the displayed image (pages 37 and 77).
<b>PROTECT</b>	—	Protects images against accidental erasure (page 70).
<b>DPOF</b>	—	Marks the print (DPOF) mark on still images you want to print (page 72).
<b>SLIDE</b>	INTERVAL IMAGE REPEAT START CANCEL	<ul style="list-style-type: none"> <li>– Sets the slide show interval (page 68). (Only in single-image mode.) <ul style="list-style-type: none"> <li>■ 3 sec / 5 sec / 10 sec / 30 sec / 1 min</li> </ul> </li> <li>– Sets the range of the playback images. <ul style="list-style-type: none"> <li>■ FOLDER / ALL</li> </ul> </li> <li>– Plays back images repeatedly. <ul style="list-style-type: none"> <li>■ ON / OFF</li> </ul> </li> <li>– Starts the slide show.</li> <li>– Cancels the slide show.</li> </ul>
<b>RESIZE</b>	2560×1920 / 2048×1536 / 1280×960 / 640×480 / CANCEL	Changes the recorded still image size (page 72). (Only in single-image mode.)
<b>ROTATE</b>	 (counter clockwise) /  (clockwise) / OK / CANCEL	Rotates the still image 90° (page 69). (Only in single-image mode.)
<b>DIVIDE</b>	OK / CANCEL	Divides a moving image (page 79). (Only in single-image mode.)

## SET UP items

Set the mode dial to SET UP. The SET UP screen appears.

Factory settings are indicated with ■.

### 📷 1 [CAMERA 1]

Item	Setting	Description
<b>MOVING IMAGE</b>	■ MPEG MOVIE / CLIP MOTION / MULTI BURST	Selects the shooting mode for a movie (pages 57, 58 and 75).
<b>DATE/TIME</b>	DAY & TIME / DATE / ■ OFF	Selects whether to superimpose the date or time onto the image (page 28). The date and time are not inserted in movie (MPEG MOVIE), Clip Motion or Multi Burst mode. Also, the date and time appear only during playback, and do not appear during recording.
<b>DIGITAL ZOOM</b>	■ ON / OFF	Selects whether to use the digital zoom (page 23).
<b>RED EYE REDUCTION</b>	ON / ■ OFF	Reduces the red-eye phenomenon when using a flash (page 26).
<b>HOLOGRAM AF</b>	■ AUTO / OFF	Selects whether to emit hologram AF light. Used when it is difficult to focus on the subject in dark conditions (page 27).
<b>CONVERSION LENS</b>	ON / ■ OFF	Set to [OFF] when using the optional conversion lens VCL-HGD0758 or VCL-HGD1758, or to [ON] when using the VCL-MHG07. Note that when a conversion lens is mounted, the weight prevents the lens portion from locking. We recommend supporting the lens portion with your left hand or using a tripod for recording.

#### When [CONVERSION LENS] is set to [ON]:

- When the mode dial is set to A or M, you can only select aperture values of F4 or higher.
- Macro shooting and zoom functions are not available.

## 2 [CAMERA 2]

Item	Setting	Description
EXPANDED FOCUS	■ON / OFF	When focusing manually, the image is enlarged to 2× (page 48).
BRACKET STEP	±1.0EV / ■±0.7EV / ±0.3EV	Sets the exposure compensation value when recording three images with each exposure value shifted (page 53).
HOT SHOE	ON / ■OFF	Sets when using a commercially available external flash (page 63).
ZOOM RING SETUP	W ↶ ↷ T / ■T ↶ ↷ W	Sets the direction in which the ring turns when you use the zoom function with the manual focus/zoom ring (page 23).

## [MEMORY STICK TOOL]

Item	Setting	Description
FORMAT	OK / CANCEL	Formats the "Memory Stick." Note that formatting erases all the data recorded on a "Memory Stick," including even erasure protected images (page 40).
CREATE REC. FOLDER	OK / CANCEL	Creates a new recording folder (page 64).
CHANGE REC. FOLDER	OK / CANCEL	Changes a recording folder (page 65).

**[SETUP 1]**

Item	Setting	Description
LCD BRIGHTNESS	BRIGHT / ■NORMAL / DARK	Selects the LCD brightness. This has no effect on the recorded images.
LCD BACKLIGHT	BRIGHT / ■NORMAL	Selects the brightness of the LCD backlight. Selecting [BRIGHT] makes the screen bright and easy to see when using the camera outdoors or in other bright locations, but also uses up the battery charge faster. Displayed only when using your camera with the battery pack.
EVF BACKLIGHT	BRIGHT / ■NORMAL	Selects the brightness of the finder backlight. Selecting [BRIGHT] makes the screen bright and easy to see when using the camera outdoors or in other bright locations, but also uses up the battery charge faster.
BEEP	SHUTTER ■ON OFF	<ul style="list-style-type: none"><li>– Turns on the shutter sound. (The shutter sound is heard when you press the shutter button.)</li><li>– Turns on the beep/shutter sound when you press the control button/shutter button.</li><li>– Turns off the beep/shutter sound.</li></ul>

**[SETUP 2]**

Item	Setting	Description
FILE NUMBER	■SERIES  RESET	<ul style="list-style-type: none"><li>– Assigns numbers to files in sequence even if the recording folder or the “Memory Stick” is changed.</li><li>– Resets the file numbering each time the recording folder is changed.</li></ul>
USB CONNECT	PTP / ■NORMAL	Switches the USB mode (page 84).
VIDEO OUT	NTSC PAL	<ul style="list-style-type: none"><li>– Sets the video output signal to NTSC mode (e.g., Japan, USA).</li><li>– Sets the video output signal to PAL mode (e.g., Europe).</li></ul>
<b>A</b> LANGUAGE	—	Displays the menu items, warnings and messages in selected language.
CLOCK SET	OK / CANCEL	Sets the date and time (page 16).



---

## Precautions

### On cleaning

#### Cleaning the LCD screen

Wipe the screen surface with an LCD cleaning kit (not supplied) to remove fingerprints, dust, etc.

#### Cleaning the lens

Wipe the lens with a soft cloth to remove fingerprints, dust, etc.

#### Cleaning the camera surface

Clean the camera surface with a soft cloth slightly moistened with water, then wipe the surface dry. Do not use any type of solvent such as thinner, alcohol or benzine as this may damage the finish or the casing.

#### After using your camera at the seashore or other dusty locations

Clean your camera carefully. Otherwise, the salty air may corrode the metal fittings or dust may enter the inside of your camera, causing a malfunction.

#### Note on operating temperature

Your camera is designed for use between the temperatures of 0°C and 40°C (32° F and 104° F). Shooting in extremely cold or hot places that exceed this range is not recommended.

### On moisture condensation

If the camera is brought directly from a cold to a warm location, or is placed in a very damp room, moisture may condense inside or outside the camera. Should this occur, the camera will not operate properly.

#### Moisture condensation occurs easily when:

- The camera is brought from a cold location such as a ski slope into a warmly heated room.
- The camera is taken from an air-conditioned room or car interior to the hot outdoors, etc.

#### How to prevent moisture condensation

When bringing the camera from a cold place to a warm place, seal the camera in a plastic bag and allow it to adapt to conditions at the new location over a period of time (about an hour).

#### If moisture condensation occurs

Turn off the camera and wait about an hour for the moisture to evaporate. Note that if you attempt to shoot with moisture remaining inside the lens, you will be unable to record clear images.

### On internal rechargeable button battery

This camera has an internal rechargeable button battery for maintaining the date and time and other settings regardless of whether the power is on or off.

This rechargeable button battery is continually charged as long as you are using the camera. However, if you use the camera for only short periods it discharges gradually, and if you do not use the camera at all for about one month it becomes completely discharged. In this case, be sure to charge this rechargeable button battery before using the camera.

However, even if this rechargeable button battery is not charged, you can still use the camera as long as you do not record the date and time.

#### Charging method

Connect the camera to a wall outlet (mains) using the AC power adaptor, or install a charged battery pack, and leave the camera for 24 hours or more with the power off.

## On “Memory Stick”

“Memory Stick” is a new compact, portable and versatile IC recording medium with a data capacity that exceeds the capacity of a floppy disk.

In addition to exchanging data between “Memory Stick” compatible equipment, you can also use a “Memory Stick” to store data as a type of detachable external recording media.

There are two types of “Memory Stick”: an ordinary “Memory Stick” and a “MagicGate Memory Stick” that is equipped with the MagicGate\* copyright protection technology. You can use both types of “Memory Stick” with your camera. However, because your camera does not support the MagicGate standards, data recorded with your camera is not subject to MagicGate copyright protection.

In addition, you can also use “Memory Stick Duo” or “Memory Stick PRO” with your camera.

\* MagicGate is copyright protection technology that uses encryption technology.

- “Memory Stick” formatted with a computer is not guaranteed to operate with this camera.

“Memory Stick” type	Recording/ playback with this camera
Memory Stick (Memory Stick Duo)	○
MagicGate Memory Stick (MagicGate Memory Stick Duo)	○**
Memory Stick PRO	○**

\*\* The camera cannot record or play back the data needed by the MagicGate function.  
All “Memory Stick” media operations are not necessarily guaranteed.

### Notes on using the supplied “Memory Stick”

- You cannot record or delete images when the write-protect switch is set to LOCK. The position or the shape of the write-protect switch may differ depending on the “Memory Stick” you use.

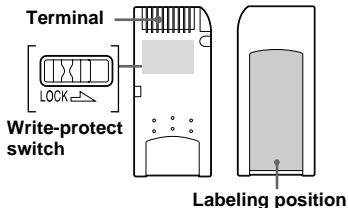

- Do not remove the “Memory Stick” while reading or writing data.

- Data may be corrupted in the following cases.
  - When the “Memory Stick” is removed or the camera is turned off during read or write operation
  - When the “Memory Stick” is used in locations subject to static electricity or electrical noise
- We recommend backing up important data.
- Do not attach any other material than the supplied label on the labeling position.
- Attach the label in the prescribed label location, taking care that the label does not extend from this location.
- When you carry or store the “Memory Stick,” put it in the case supplied with it.
- Do not touch the terminal of a “Memory Stick” with your hand or a metal object.
- Do not strike, bend or drop a “Memory Stick.”
- Do not disassemble or modify a “Memory Stick.”
- Do not expose the “Memory Stick” to water.
- Do not use or keep the “Memory Stick” under the following conditions:
  - High temperature locations such as the hot interior of a car parked in direct sunlight
  - Locations exposed to direct sunlight
  - Humid locations or locations with corrosive substances

### Notes on using “Memory Stick Duo” (not supplied)

- When using a “Memory Stick Duo” with your camera, be sure to insert the “Memory Stick Duo” into a “Memory Stick Duo” Adaptor.
- When inserting a “Memory Stick Duo” into a “Memory Stick Duo” Adaptor, check to make sure the “Memory Stick Duo” is inserted facing the correct direction.

- When using a “Memory Stick Duo” inserted into a “Memory Stick Duo” Adaptor with this camera, make sure that the “Memory Stick Duo” is inserted facing the correct direction. Note that improper use may damage the equipment.
- Do not insert a “Memory Stick Duo” without a “Memory Stick Duo” Adaptor into “Memory Stick” compatible equipment, as this may cause equipment trouble.

### Note on using “Memory Stick PRO” (not supplied)

- “Memory Stick PRO” with a capacity up to 1GB can be used with this camera.

## On “InfoLITHIUM” battery pack



### What is the “InfoLITHIUM” battery pack?

The “InfoLITHIUM” battery pack is a lithium-ion battery pack that has functions for communicating information related to operating conditions between your camera and the AC power adaptor.

The “InfoLITHIUM” battery pack calculates the power consumption according to the operating conditions of your camera, and displays the remaining battery time in minutes.

### Charging the battery pack

We recommend charging the battery pack in an ambient temperature of between 10°C to 30°C (50°F to 86°F). You may not be able to efficiently charge the battery pack outside of this temperature range.

### Effective use of the battery pack

- Battery performance decreases in low-temperature surroundings. So, the time that the battery pack can be used is shorter in cold places. We recommend the following to ensure longer battery pack use:
  - Put the battery pack in a pocket close to your body to warm it up, and insert it in your camera immediately before you start shooting.
- Frequently operating the zoom or flash wears out the battery charge faster.
- We recommend having spare battery packs handy for two or three times the expected shooting time, and making trial shots before taking the actual shots.
- Do not expose the battery pack to water. The battery pack is not water-resistant.

### Remaining battery time indicator

The power may go off although the battery remaining indicator shows there is enough power to operate. Use the battery pack up and charge the battery pack fully again so that the indication on the battery remaining indicator is correct. Note, however, that the correct battery indication sometimes will not be restored if the camera is used in high temperatures for a long time or left in a fully charged state, or the battery pack is frequently used.

## How to store the battery pack

- Even if the battery pack will not be used for a long time, fully charge it and use it up once per year. Remove the battery pack from your camera, then store it in a dry, cool place. This is to maintain the battery pack's functions.
- To use the battery pack up on your camera, leave the POWER switch to on in slide show playback mode (page 68) until the power goes off.

## Battery life

- The battery life is limited. Battery capacity decreases little by little as you use it more and more, and as time passes. When the battery operating time is shortened considerably, a probable cause is that the battery pack has reached the end of its life. Buy a new battery pack.
- The battery life varies according to how it is stored and the operating conditions and environment for each battery pack.

## Specifications

### System

#### Image device

11 mm (2/3 type) color CCD  
Primary color filter

#### Total pixels number of camera

Approx. 5 240 000 pixels

#### Effective pixels number of camera

Approx. 5 020 000 pixels

#### Lens

5× zoom lens  
f = 9.7 – 48.5 mm (13/32 –  
1 15/16 inches) (38 – 190 mm  
(1 1/2 – 7 1/2 inches) when converted  
to a 35 mm still camera)  
F2.0 – 2.4  
Filter diameter: 58 mm (2 3/8 inches)

#### Exposure control

Automatic exposure, Shutter speed  
priority, Aperture priority, Manual  
exposure, Scene selection (4 modes)

#### White balance

Automatic, Daylight, Cloudy,  
Fluorescent, Incandescent, One-push

#### Data format (DCF compliant)

Still images: Exif Ver. 2.2 JPEG  
compliant, GIF (for Clip Motion),  
TIFF, DPOF compatible  
Audio with still image:  
MPEG1 compliant (Monaural)  
Moving images:  
MPEG1 compliant (Monaural)

#### Recording media

“Memory Stick”

#### Flash

Recommended distance (ISO set to  
Auto): 0.3 m to 4.5 m (11 7/8 inches  
to 177 1/4 inches)

### Viewfinder

Electric viewfinder (color)

## Input/Output connectors

### A/V OUT (MONO) (Monaural)

Minijack  
Video: 1 Vp-p, 75 Ω unbalanced,  
sync negative  
Audio: 327 mV (at a 47 kΩ load)  
Output impedance 2.2 kΩ

### ACC jack

Mini-minijack (ø 2.5 mm)

### USB jack

mini-B

## LCD screen

### Used LCD panel

4.6 cm (1.8 type) TFT drive

### Total number of dots

123 200 (560×220) dots

## General

### Used battery pack

NP-FM50 (supplied)

### Power requirements

7.2 V

### Power consumption (during shooting)

2.3 W

### Operating temperature

0°C to 40°C (32°F to 104°F)

### Storage temperature

–20°C to +60°C (–4°F to +140°F)

### Dimensions

119.5×68.9×151 mm  
(4 3/4×2 3/4×6 inches)  
(W/H/D, excluding maximum  
protrusions)

### Mass

Approx. 696 g (1 lb 8 oz) (including  
battery pack NP-FM50, “Memory  
Stick,” shoulder strap and lens cap)

**Built-in microphone**

Electret condenser microphone

**Built-in speaker**

Dynamic speaker

**AC-L10A/L10B AC power adaptor****Power requirements**

100 to 240 V AC, 50/60 Hz

**Rated output voltage**

DC 8.4 V, 1.5 A in operating mode

**Operating temperature**

0°C to 40°C (32°F to 104°F)

**Storage temperature**

-20°C to +60°C (-4°F to +140°F)

**Dimensions**

Approx. 125×39×62 mm  
(5×1 9/16×2 1/2 inches) (w/h/d,  
excluding maximum protrusions)

**Mass** Approx. 280 g (10 oz)

**NP-FM50 battery pack****Used battery**

Lithium-ion battery

**Maximum voltage**

DC 8.4 V

**Nominal voltage**

DC 7.2 V

**Capacity** 8.5 Wh (1 180 mAh)

**Operating temperature**

0°C to 40°C (32°F to 104°F)

**Dimensions**

Approx. 38.2×20.5×55.6 mm  
(1 9/16×13/16×2 1/4 inches) (w/h/d)

**Mass** Approx. 76 g (3 oz)

**Accessories**

- AC-L10A/L10B AC power adaptor
- Power cord (mains lead)
- USB cable
- NP-FM50 battery pack
- A/V connecting cable
- “Memory Stick” (32 MB)
- Shoulder strap
- Lens cap
- Lens cap strap
- CD-ROM (USB driver SPVD-008)
- Operating instructions

Design and specifications are subject to change without notice.

## FINDER/LCD screen

### When shooting still images

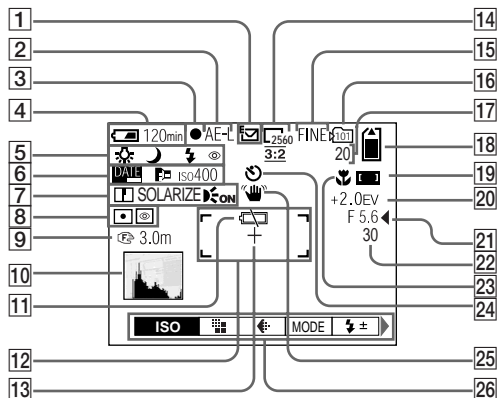

- 15 Image quality indicator (31)
- 16 Recording folder indicator (64)
- 17 Remaining number of recordable images indicator (32, 104)/ Self-diagnosis display (103)
- 18 Remaining "Memory Stick" capacity indicator
- 19 Focus range indicator (46)
- 20 EV level indicator (49)
- 21 Aperture value indicator (44)
- 22 Shutter speed indicator (44)
- 23 Macro indicator (24)
- 24 Self-timer indicator (25)
- 25 Light amount warning indicator
- 26 Menu/Guide menu (42)

- Pressing MENU switches the menu on/off.

- 1 Recording mode indicator (57-61)
- 2 AE LOCK indicator (52)
- 3 AE/AF lock indicator (20)
- 4 Battery remaining indicator (12)
- 5 White balance indicator (54)/ Mode dial indicator/ Flash mode indicator (26)/ Red-eye reduction indicator (26)/ Hot shoe indicator (63)
- 6 Date/time indicator (28)/ Conversion lens indicator (110)/ ISO number indicator (107)
- 7 Sharpness indicator (107, 108)/ Picture effect indicator (62)/ Hologram AF indicator (27)
- 8 Metering modes indicator (51)/ NightShot/NightFraming indicator (55)
- 9 Focus distance indicator (48)
- 10 Histogram indicator (50)
- 11 Low battery warning indicator (12)
- 12 AF range finder (46)
- 13 Spot metering cross hair (51)
- 14 Image size indicator (19)

## When shooting movies

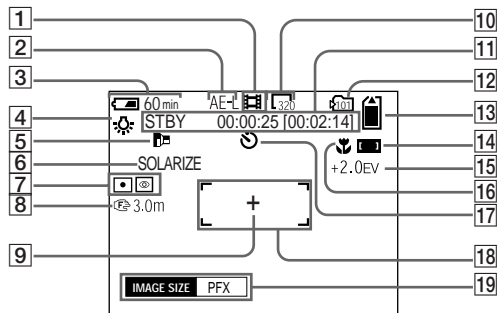

- |                                                                                           |                                                       |
|-------------------------------------------------------------------------------------------|-------------------------------------------------------|
| <b>1</b> Recording mode indicator (75)                                                    | <b>12</b> Recording folder indicator (64)             |
| <b>2</b> AE LOCK indicator (52)                                                           | <b>13</b> Remaining “Memory Stick” capacity indicator |
| <b>3</b> Battery remaining indicator (12)                                                 | <b>14</b> Focus range indicator (46)                  |
| <b>4</b> White balance indicator (54)                                                     | <b>15</b> EV level indicator (49)                     |
| <b>5</b> Conversion lens indicator (110)                                                  | <b>16</b> Macro indicator (24)                        |
| <b>6</b> Picture effect indicator (62)                                                    | <b>17</b> Self-timer indicator (25)                   |
| <b>7</b> Metering modes indicator (51)/<br>NightShot/NightFraming indicator (55)          | <b>18</b> AF range finder (46)                        |
| <b>8</b> Focus distance indicator (48)                                                    | <b>19</b> Menu/Guide menu (42)                        |
| <b>9</b> Spot metering cross hair (51)                                                    |                                                       |
| <b>10</b> Image size indicator (75)                                                       |                                                       |
| <b>11</b> Recording time [maximum recordable time] indicator/Self-diagnosis display (103) |                                                       |

• Pressing MENU switches the menu on/off.

Page numbers in parentheses indicate the location of additional important information.

## When playing back still images

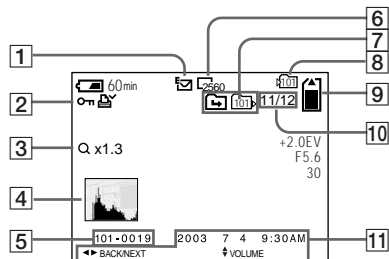

- 1 Recording mode indicator (57-61)
- 2 Protect indicator (70)/  
Print (DPOF) mark indicator (72)/  
Volume indicator (61)
- 3 Zoom scaling indicator (67)
- 4 Histogram indicator (50)
- 5 File name (88)
- 6 Image size indicator (19)
- 7 Change folder indicator/  
Playback folder indicator (66)
- 8 Recording folder indicator (67,  
72)
- 9 Remaining "Memory Stick"  
capacity indicator
- 10 Image number/Number of  
images recorded in selected  
folder
- 11 Recording date of the playback  
image (28)/Menu/Guide menu  
(42)

## When playing back moving images

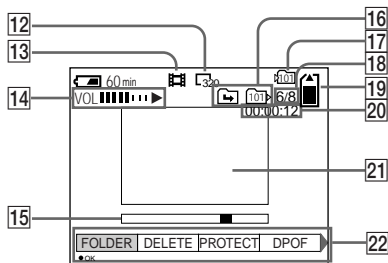

- 12 Image size indicator (76)
- 13 Recording mode indicator (76)
- 14 Volume indicator (76)/Playback  
indicator (76)
- 15 Playback bar (76)
- 16 Change folder indicator/  
Playback folder indicator (66)
- 17 Recording folder indicator (80)
- 18 Image number/Number of  
images recorded in selected  
folder
- 19 Remaining "Memory Stick"  
capacity indicator
- 20 Counter (76)
- 21 Playback image (76)
- 22 Menu/Guide menu (42)

Page numbers in parentheses indicate the location of additional important information.



# Index

## A

AC power adaptor .....	11, 14
Access lamp .....	18
AE lock .....	52
AF lock .....	47
AF range .....	46
Aperture priority mode .....	45
Auto adjustment mode .....	20
Auto Focus .....	21, 46
Auto power-off function .....	15

## B

Battery pack	
battery life .....	13, 116
charging .....	11, 115
charging time .....	12
remaining indicator .....	12, 115
Beep/shutter sound .....	112
Bracket .....	53
Brightness	
EVF finder .....	112
image .....	49, 53
LCD screen .....	112
Burst .....	59

## C

CD-ROM .....	81
Charging	
battery pack .....	11, 115
charging time .....	12

Cleaning .....	113
Clip Motion .....	57
Clock set .....	16
Computer	
copying images .....	85, 86, 91
Image Transfer .....	82
ImageMixer .....	84
USB cable .....	84
USB driver .....	82
Control button .....	9, 15, 42
Conversion lens .....	110
Copying images .....	85, 86, 91

## D

Deleting images .....	37, 77
Digital zoom .....	23
DISPLAY .....	22
DIVIDE .....	79
DPOF .....	72

## E

Editing still images	
Print (DPOF) mark .....	72
Protect .....	70
Resize .....	72
E-mail .....	61
Enlarging an image .....	66
EV adjustment .....	49
EXPANDED FOCUS .....	48, 111
Exposure bracket .....	53

## F

### File

file names .....	88
image file storage destinations .....	88

### Flash

external flash .....	63
FLASH LEVEL .....	107, 108
Red-eye reduction .....	26, 110
selecting a flash mode .....	26

### Focusing

AF lock .....	47
FOCUS range select function .....	46
manual focus .....	48
Multipoint AF .....	46
shooting (using auto adjustment mode) .....	20, 46

### Folder

playback folder .....	66
recording folder .....	64

FORMAT .....	40
--------------	----

## G

GIF .....	57, 89
-----------	--------

## H

Hologram AF .....	27, 110
Hot shoe .....	63, 111

<b>I</b>	
Image	
copying images .....	85, 86, 91
file names .....	88
image file storage destinations .....	88
image quality .....	32
image size .....	19, 32, 104, 106
“InfoLITHIUM” battery pack .....	115
Installation	
Image Transfer .....	82
ImageMixer .....	84
USB driver .....	82
ISO .....	107
<b>J</b>	
Jog dial .....	43
JPEG .....	20, 89
<b>L</b>	
LCD screen .....	112
<b>M</b>	
Manual exposure mode .....	45
Memory Stick	
formatting a “Memory Stick” .....	40
inserting a “Memory Stick” .....	18
number of shooting images/time .....	32, 104
Menu settings .....	42, 106
Metering mode	
center-weighted metering .....	51
multi-pattern metering .....	51
spot metering .....	51
Mode dial .....	8, 16, 42

Moisture condensation .....	113
Movie	
cutting movies .....	79
deleting images .....	77
number of images that can be saved or shooting time .....	13, 104
shooting images .....	75
viewing images on a screen .....	76
viewing images on your computer .....	88
MPEG MOVIE .....	75
MPG .....	89
Multi Burst .....	58

<b>N</b>	
NightFraming .....	56
NightShot .....	56
NR slow shutter .....	45
NTSC system .....	36, 112

<b>P</b>	
PAL system .....	36, 112
Picture effect .....	62
Power	
AC power adaptor .....	14
battery pack .....	11
on/off .....	15
Precautions .....	113
Print (DPOF) mark .....	72
Protect .....	70

<b>Q</b>	
Quick Review .....	21

<b>R</b>	
Red-eye reduction .....	26, 110
RESET button .....	92, 103
Resize .....	72
Rotate .....	69

<b>S</b>	
Scene Selection (SCN) .....	29
Self-diagnosis display .....	103
Self-timer .....	25
Setting	
date and time .....	16
image quality .....	32
image size .....	19, 32, 104
menu items .....	42, 106
SET UP items .....	42, 110
SHARPNESS .....	107, 108
Shooting mode	
auto adjustment mode .....	20
Bracket .....	53
Burst .....	59
Clip Motion .....	57
E-mail .....	61
movie .....	75
Multi Burst .....	58
TIFF .....	60
Voice .....	61
Shutter speed priority mode .....	44
Slide show .....	68

Still image shooting	
EV adjustment .....	49
image size .....	19
metering mode .....	51
number of shooting images .....	32, 104
picture effect .....	62
Scene Selection .....	29
shooting close-ups (Macro) .....	24
superimposing the date and time .....	28
using auto adjustment mode .....	20
using the flash .....	26
using the self-timer .....	25
using the zoom .....	23
White Balance .....	54
Still image viewing	
delete .....	37
index screen .....	34
playback zoom .....	67
rotate .....	69
single image screen .....	33
slide show .....	68
viewing images on a screen .....	33
viewing images on a TV screen .....	35
viewing images on your computer .....	88
Superimposing the date and time .....	28

## T

TIFF .....	60
Trimming .....	67
TV color system .....	35

## U

USB .....	81, 85
Using your camera abroad .....	14

## V

Viewing images on a screen .....	33, 76
Viewing images on your computer .....	88
Voice .....	61

## W

Warnings and notice messages .....	101
White Balance .....	54

## Z

### Zoom

digital zoom .....	23, 110
playback zoom .....	67
using the zoom feature .....	23

307804514



Printed on 100% recycled paper  
using VOC (Volatile Organic  
Compound)-free vegetable oil  
based ink.

<http://www.sony.net/>  
Sony Corporation Printed in Japan

Additional information on this product and answers to frequent  
asked questions can be found at our Customer Support Website.