

K-75XR90M2

SONY

スタンドあり

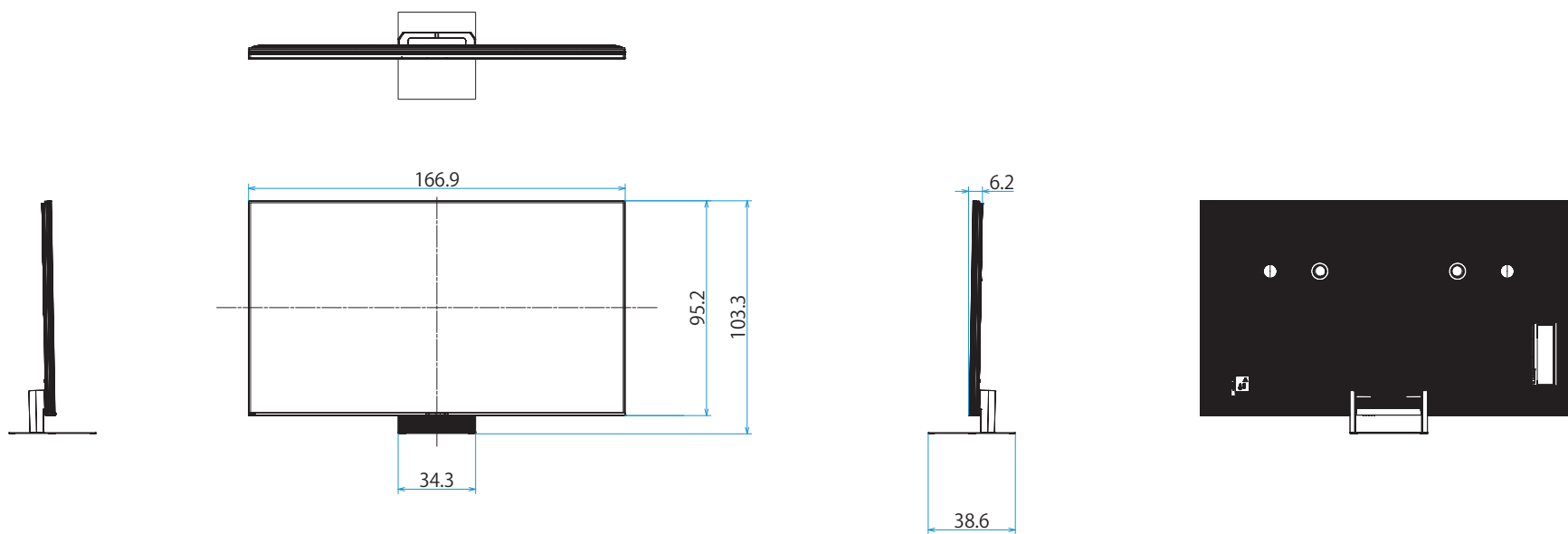

単位：cm

スタンドなし

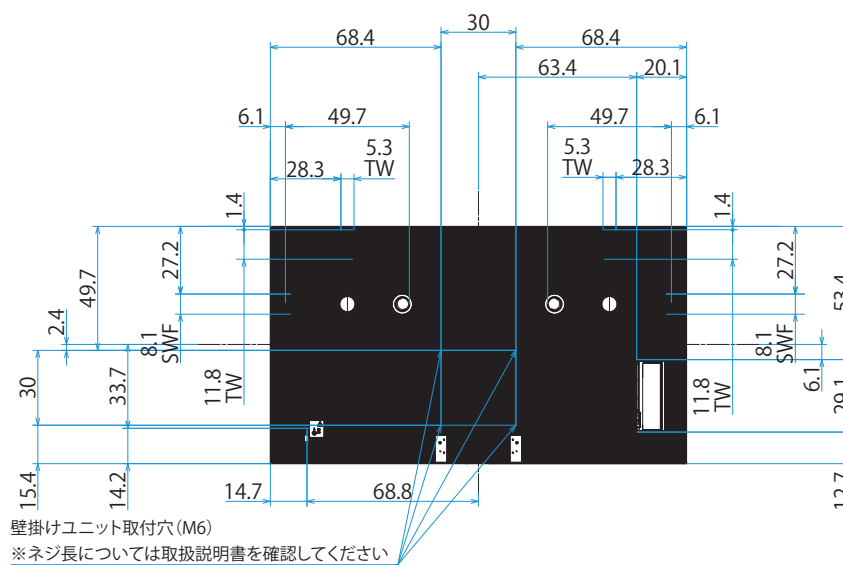
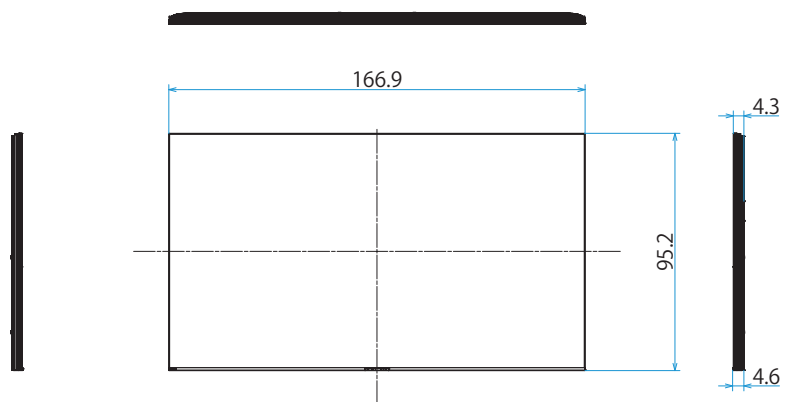

壁掛けユニット取付穴 (M6)
 ※ネジ長については取扱説明書を確認してください

壁掛け

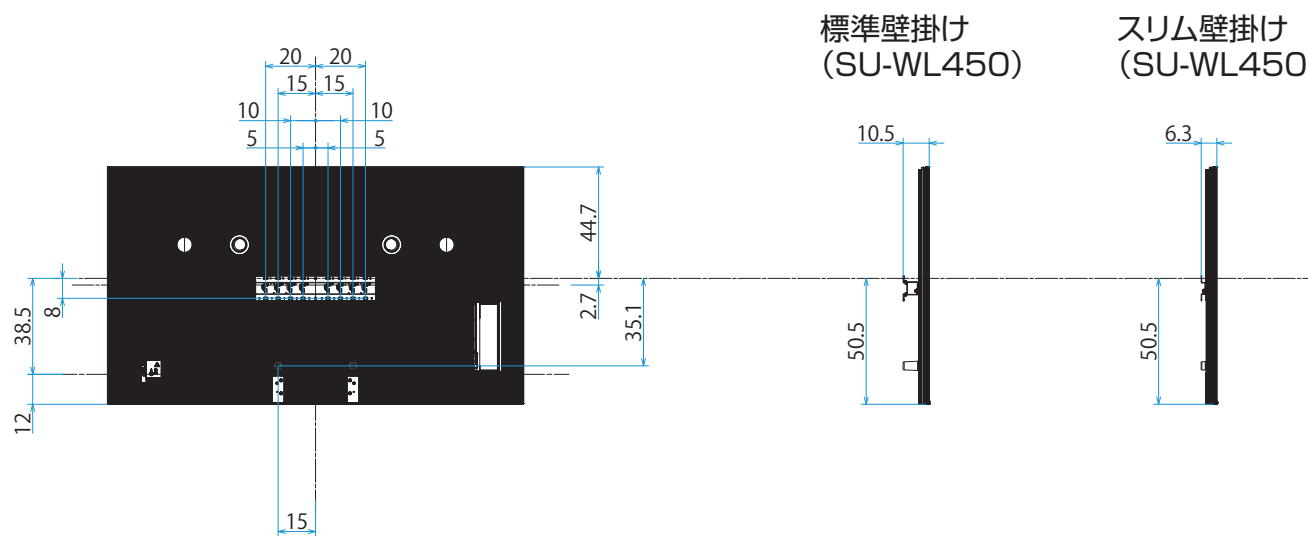

壁掛けブラケット装着時
(SU-WL900)



標準壁掛け スリム壁掛け

