

SONY®

Cyber-shot

Digital Still Camera

Cyber-shot Handbook

DSC-W300

Before operating the unit, please read this Handbook thoroughly together with the “**Instruction Manual**” and the “**Cyber-shot Step-up Guide**”, and retain them for future reference.

▼CLICK!



Table of contents



Basic Operations



Using the shooting functions



Using the viewing functions



Customizing the settings



Viewing images on a TV



Using your computer



Printing still images



Troubleshooting



Others



Index

Notes on using the camera

Notes on the types of “Memory Stick” that you can use (not supplied)



“Memory Stick Duo”

You can use a “Memory Stick Duo” with the camera.



“Memory Stick”

You cannot use a “Memory Stick” with the camera.

Other memory cards cannot be used.

- For details on “Memory Stick Duo”, see page 136.

When using a “Memory Stick Duo” with “Memory Stick” compatible equipment

You can use the “Memory Stick Duo” by inserting it into the Memory Stick Duo Adaptor (not supplied).



Memory Stick Duo Adaptor

Notes on the battery pack

- Charge the battery pack (supplied) before using the camera for the first time.
- You can charge the battery pack even if it is not completely discharged. In addition, even if the battery pack is not fully charged, you can use the partially charged capacity of the battery pack as is.
- If you do not intend to use the battery pack for a long time, use up the existing charge and remove it from the camera, then store it in a cool, dry place. This is to maintain the battery pack functions.
- For details on the usable battery pack, see page 138.

Carl Zeiss lens

The camera is equipped with a Carl Zeiss lens which is capable of reproducing sharp images with excellent contrast.

The lens for the camera has been produced under a quality assurance system certified by Carl Zeiss in accordance with the quality standards of Carl Zeiss in Germany.

Notes on the LCD screen and lens

- The LCD screen is manufactured using extremely high-precision technology so over 99.99% of the pixels are operational for effective use. However, some tiny black and/or bright dots (white, red, blue or green) may appear on the LCD screen. These dots are a normal result of the manufacturing process, and do not affect the recording.

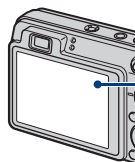

Black, white, red, blue or green dots

- Exposing the LCD screen or the lens to direct sunlight for long periods may cause malfunctions. Be careful when placing the camera near a window or outdoors.
- Do not press against the LCD screen. The screen may be discolored and that may cause a malfunction.
- Images may trail across on the LCD screen in a cold location. This is not a malfunction.
- Be careful not to bump the movable lens, and be careful not to apply force to it.

The images used in this Handbook

The images used as examples in this Handbook are reproduced images, and are not actual images shot using the camera.

Table of contents

| | |
|-----------------------------------------------------|----|
| Notes on using the camera | 2 |
| Basic techniques for better images | 7 |
| Focus – Focusing on a subject successfully | 7 |
| Exposure – Adjusting the light intensity | 9 |
| Color – On the effects of lighting | 10 |
| Quality – On “image quality” and “image size” | 11 |
| Flash – On using the flash | 13 |
| Identifying parts | 14 |
| Indicators on the screen | 16 |
| Changing the screen display | 20 |
| Using the internal memory | 22 |

Basic Operations















| | |
|-------------------------------------------------|----|
| Using the mode dial..... | 23 |
| Shooting images (Auto Adjustment mode)..... | 24 |
| Shooting still images (Scene Selection) | 28 |
| Shooting with the manual exposure | 34 |
| Viewing images | 36 |
| Viewing still images as a slideshow | 38 |
| Deleting images..... | 42 |
| Learning the various functions – HOME/Menu..... | 44 |
| Menu items..... | 47 |

Using the shooting functions



| | |
|-------------------------------------------------------------------------|----|
| Shooting menu | 49 |
| Scene Selection: Selecting the Scene Selection | |
| Image Size: Selecting the image size | |
| Flash: Flash setting | |
| Face Detection: Detecting the face of subject | |
| Smile Detection: Setting the Smile Detection function | |
| Smile Detection Sensitivity: Setting the Smile Detection Sensitivity | |
| REC Mode: Selecting the continuous shooting method | |
| Scene Recognition: Determining the scene to be shot and taking the shot | |
| EV: Adjusting the light intensity | |
| ISO: Selecting a luminous sensitivity | |
| Metering Mode: Selecting the metering mode | |
| Focus: Changing the focus method | |
| White Balance: Adjusting the color tones | |









- Underwater White Balance: Adjusting color tones during Underwater mode
- Flash Level: Adjusting the amount of flash light
- Red Eye Reduction: Setting the Red Eye Reduction function
- DRO: Optimizing the brightness and contrast
- Noise Reduction: Adjusting the Noise Reduction
- Color Mode: Changing the vividness of the image or adding special effects
- Color Filter: Setting the Color Filter function
- Color Saturation: Adjusting the Color Saturation
- Contrast: Adjusting the Contrast
- Sharpness: Adjusting the Sharpness
- SteadyShot: Selecting the anti-blur mode
-  (Shooting Settings): Selecting the Shooting Settings

Using the viewing functions

- Selecting the View Mode 68
 -  (Date View): Display by date
 -  (Folder View): Display by folder
 -  (Favorites): Displaying images registered as Favorites
- Viewing menu 69
 -  (Delete): Deleting images
 -  (View Mode): Switching the View Modes
 -  (Date List): Selecting the playback date when using Date View
 -  (Filter by Faces): Playing back images filtered to meet certain conditions
 -  (Add / Remove Favorites): Adding/Removing Favorites
 -  (Slideshow): Playing back a series of images
 -  (Retouch): Retouching still images
 -  (Multi-Purpose Resize): Changing the image size according to usage
 -  (Protect): Preventing accidental erasure
 - DPOF**: Adding a Print order mark
 -  (Print): Printing images using a printer
 -  (Rotate): Rotating a still image
 -  (Select Folder): Selecting the folder for viewing images

Customizing the settings

- Customizing the Manage Memory feature and the Settings 80
-  **Manage Memory** 82
-  **Memory Tool — Memory Stick Tool** 82
 - Format Change REC.Folder
 - Create REC.Folder Copy

| | |
|---------------------------------------------------------------------------------------------------------------------------------|-------------------|
|  Memory Tool — Internal Memory Tool | 84 |
| Format | |
|  Settings..... | 85 |
|  Main Settings — Main Settings 1..... | 85 |
| Beep | Initialize |
| Function Guide | Smile demo mode |
|  Main Settings — Main Settings 2..... | 87 |
| USB Connect | Video Out |
| COMPONENT | Wide Zoom Display |
|  Shooting Settings — Shooting Settings 1 | 89 |
| AF Illuminator | Digital Zoom |
| Grid Line | Conversion Lens |
| AF Mode | |
|  Shooting Settings — Shooting Settings 2 | 92 |
| Auto Orientation | Auto Review |
|  Clock Settings | 93 |
|  Language Setting..... | 94 |

Viewing images on a TV

| | |
|-----------------------------|----|
| Viewing images on a TV..... | 95 |
|-----------------------------|----|

Using your computer

| | |
|-------------------------------------------------------------------------------------------------|-----|
| Enjoying your Windows computer | 98 |
| Installing the software (supplied)..... | 100 |
| On the “Picture Motion Browser” (supplied) | 102 |
| Copying images to your computer using the “Picture Motion Browser” | 103 |
| Copying images to a computer without “Picture Motion Browser”..... | 107 |
| Viewing image files stored on a computer with the camera copying to the “Memory Stick Duo”..... | 109 |
| Using the “Music Transfer” (supplied) | 110 |
| Using your Macintosh computer..... | 111 |
| Viewing “Cyber-shot Step-up Guide” | 113 |

Printing still images

| | |
|---------------------------------------------------------------------|-----|
| How to print still images | 114 |
| Printing images directly using a PictBridge compliant printer | 115 |
| Printing at a shop | 118 |

Troubleshooting

| | |
|---------------------------------------|-----|
| Troubleshooting | 120 |
| Warning indicators and messages | 131 |

Others

| | |
|-----------------------------------------------|-----|
| Using the camera abroad — Power sources | 135 |
| On the “Memory Stick Duo” | 136 |
| On the battery pack | 138 |
| On the battery charger | 139 |
| On Cyber-shot Station | 140 |

Index

| | |
|-------------|-----|
| Index | 141 |
|-------------|-----|

Basic techniques for better images

Focus

Exposure

Color

Quality

Flash



This section describes the basics so you can enjoy the camera. It tells you how to use various camera functions such as the mode dial (page 23), the HOME screen (page 44) and the menus (page 46).

Focus *Focusing on a subject successfully*

When you press the shutter button halfway down, the camera adjusts the focus automatically (Auto Focus). Remember to press the shutter button only halfway down.

Do not fully press the shutter button straight away.



Press the shutter button halfway down.



AE/AF lock indicator flashing → lit/beeps



Then press the shutter button fully down.

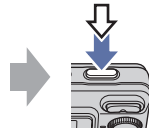

When focusing is difficult → [Focus] (page 58)

If the image looks blurred even after focusing, it may be because of camera shake. → See "Hints for preventing blur" below.

Hints for preventing blur

The camera moved accidentally when you took the image. This is called “Camera shake”. On the other hand, if the subject moved when you took the image, it is called “subject blur”.

Camera shake

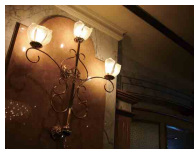

Cause

Your hands or body shake while you hold the camera and press the shutter button, and the entire screen is blurred.

What you can do to reduce the blurring

- Use a tripod or place the camera on a flat surface to hold the camera steady.
- Shoot with a 2-second delay self-timer and stabilize the camera by holding your arms firmly at your side after pressing the shutter button.

Subject blur





Cause

Even though the camera is steady, the subject moves during the exposure so the subject looks blurred when the shutter button is pressed.

What you can do to reduce the blurring

- Select **ISO** (High Sensitivity) mode or **ISO+** (Extra High Sensitivity) mode in Scene Selection.
- Select a higher ISO sensitivity to make the shutter speed faster, and press the shutter button before the subject moves.

Notes

- The anti-blur function is enabled in the factory default settings so that the camera shake is reduced automatically. However, this is not effective for subject blur.
- Besides, camera shake and subject blur occur frequently under low-light or slow shutter speed conditions, such as those encountered in  (Twilight) mode or  (Twilight Portrait) mode. In that case, shoot with the above tips in mind.

Exposure *Adjusting the light intensity*

You can create various images by adjusting the exposure and the ISO sensitivity. Exposure is the amount of light that the camera will receive when you release the shutter.

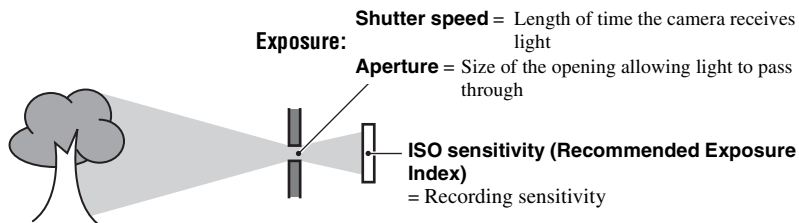

Overexposure
= too much light
Whitish image



Correct exposure



Underexposure
= too little light
Darker image

The exposure is automatically set to the proper value in the Auto Adjustment mode. However, you can adjust it manually using the functions below.

Manual exposure:

Allows you to adjust the shutter speed and aperture value manually (page 34).

Adjusting EV:

Allows you to adjust the exposure determined by the camera (page 55).

Metering Mode:

Allows you to change the part of the subject to be measured to determine the exposure (page 57).

Adjusting ISO Sensitivity (Recommended Exposure Index)

ISO sensitivity is a speed rating for recording media that incorporates an image sensor that receives light. Even when the exposure is the same, images differ depending on the ISO sensitivity.

To adjust the ISO sensitivity, see page 56.



High ISO sensitivity

Records a bright image even in dark locations while increasing shutter speed to reduce blur.

However, the image tends to become noisy.



Low ISO sensitivity

Records a smoother image.





However, when the exposure is insufficient, the image may become darker.

Color

On the effects of lighting

The apparent color of the subject is affected by the lighting conditions.

Example: The color of an image affected by light sources

| Weather/lighting | Daylight | Cloudy | Fluorescent | Incandescent |
|--------------------------|-------------------------------------------------------------------------------------------------------|---------------------------------------------------------------------------------------------|---------------------------------------------------------------------------------------------------|----------------------------------------------------------------------------------------------|
| Characteristics of light | White (standard)  | Bluish  | Green-tinged  | Reddish  |

The color tones are adjusted automatically in the Auto Adjustment mode.

However, you can adjust color tones manually with [White Balance] (page 60).

Quality On “image quality” and “image size”

A digital image is made up of a collection of small dots called pixels.

If it contains a large number of pixels, the image becomes large, it takes up more memory, and the image is displayed in fine detail. “Image size” is shown by the number of pixels. Although you cannot see the differences on the screen of the camera, the fine detail and data processing time differ when the image is printed or displayed on a computer screen.

Description of the pixels and the image size

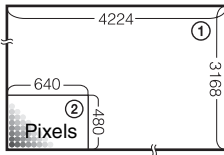

- ① Image size: 13M
 $4224 \text{ pixels} \times 3168 \text{ pixels} = 13,381,632 \text{ pixels}$
- ② Image size: VGA
 $640 \text{ pixels} \times 480 \text{ pixels} = 307,200 \text{ pixels}$

Selecting the image size for use (page 12)



Pixel

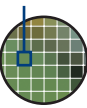

Many pixels (Fine image quality and large file size)



Example: Printing in up to A3+ size







Few pixels (Rough image quality but small file size)



Example: An attached image to be sent by e-mail

Basic techniques for better images

The default settings are marked with ✓.

| | Image size | Usage guidelines | No. of images | Printing |
|---|-----------------------------------------|--------------------------------------------------------|-------------------------------------------------------------------------------------------|--------------------------------------------------------------------------------------------|
| ✓ | 13M (4224×3168) | For prints up to A3+(13×19") | Less  | Fine  |
| | 3:2 (12M) ^{*1} (4224×2816) | Shoot in 3:2 aspect ratio | ↑ ↓ | ↑ ↓ |
| | 8M (3264×2448) | For prints up to A3(11×17") | | |
| | 5M (2592×1944) | For prints up to A4(8×10") | ↓ ↑ | ↓ ↑ |
| | 3M (2048×1536) | For prints up to 10×15 cm (4×6") or 13×18 cm (5×7") | | |
| | VGA (640×480) | Shoot at small image size for e-mail attachments | | |
| | 16:9 (10M) ^{*2} (4224×2376) | For viewing on HDTVs and printing up to A3(11×17") | Less  | Fine  |
| | 16:9 (2M) ^{*2} (1920×1080) | For viewing on HDTVs | ↓ ↑ | ↓ ↑ |
| | | | More | Rough  |

*1) Images are recorded in 3:2 aspect ratio, same as photograph printing paper or postcards, etc.

*2) Both edges of the image may be cut off when printing (page 128).

| | Movie image size | Frame/Second | Usage guidelines |
|---|-------------------------|--------------|-------------------------------------------------|
| | 640(Fine) (640×480) | Approx. 30 | Shoot high quality movie for display on TV |
| ✓ | 640(Standard) (640×480) | Approx. 17 | Shoot standard quality movie for display on TV |
| | 320 (320×240) | Approx. 8 | Shoot at small image size for e-mail attachment |

• The larger the image size, the higher the image quality.

• The higher the number of frames per second, the smoother the playback image.

Flash *On using the flash*

The eyes of the subject may come out red, or fuzzy white circular spots may appear when using the flash. These phenomena can be reduced by taking the following steps.

The “Red-eye phenomenon”

Pupils become dilated in dark environments. Flash light is reflected off the blood vessels at the back of the eye (retina), causing the “red-eye” phenomenon.



How can the “Red-eye phenomenon” be reduced?

- Set [Red Eye Reduction] to [On] (page 63).
- Select ISO (High Sensitivity) mode* or ISO^+ (Extra High Sensitivity) mode* in Scene Selection (page 29). (The flash is turned off automatically.)
- When the eyes of the subject turn out red, correct the image with [Retouch] on the viewing menu (page 72) or with the supplied software “Picture Motion Browser”.

The “White circular spots”

This is caused by particles (dust, pollen, etc.) floating close to the lens. When they are accentuated by the camera’s flash, they appear as white circular spots.

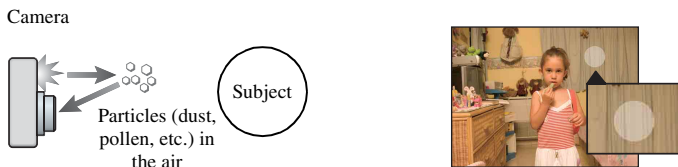

How can the “White circular spots” be reduced?

- Light the room and shoot the subject without a flash.
 - Select ISO (High Sensitivity) mode* or ISO^+ (Extra High Sensitivity) mode* in Scene Selection. (The flash is turned off automatically.)
- * Even though you selected ISO (High Sensitivity) mode or ISO^+ (Extra High Sensitivity) mode in Scene Selection, the shutter speed might be slower under low-light conditions, or in a dark place. In that case, use a tripod or hold your arms firmly at your side after pressing the shutter button.

Identifying parts

See the pages in parentheses for details of operation.

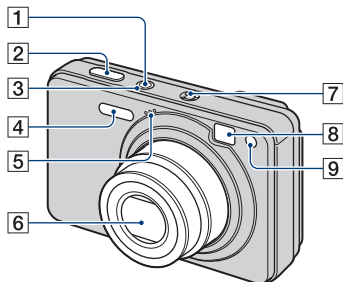

- 1 POWER button
- 2 Shutter button (24)
- 3 POWER lamp
- 4 Flash (26)
- 5 Microphone
- 6 Lens
- 7 Speaker
- 8 Finder window
- 9 Self-timer lamp (27)/
Smile Shutter lamp (32)/
AF illuminator (89)

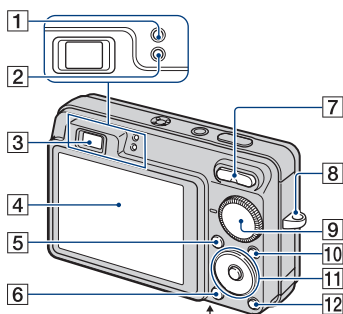

Bottom

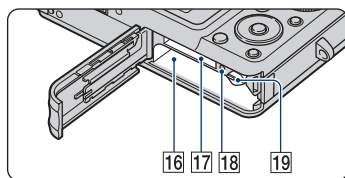
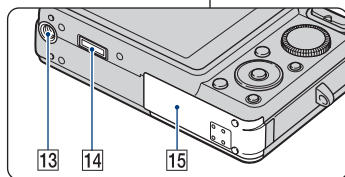

- 1 AE/AF lock lamp (green)
- 2 Flash charge lamp/
Record lamp (orange)
- 3 Finder
- 4 LCD screen (20)
- 5 MENU button (46)
- 6 ► (Playback) button (36)
- 7 For shooting: W/T (Zoom) button (25)
For viewing: ◀/▶ (Playback zoom)
button (36)/☒ (Index) button (37)
- 8 Hook for wrist strap
- 9 Mode dial (23)
- 10 HOME button (44)

Identifying parts

- 11** Control button
Menu on: ▲/▼/◀/▶/● (46)
Menu off: DISP/☺/📷/🔋 (20, 26, 27)
When the mode dial is set to M:
Shutter Speed/Aperture (34)
- 12**  (Slideshow) button (38)
- 13** Tripod receptacle
- Use a tripod with a screw less than 5.5 mm (7/32 inch) long. Otherwise, you cannot firmly secure the camera, and damage to the camera may occur.
- 14** Multi connector
Used in the following situations:
- Making a USB connection between the camera and the computer.
 - Making a connection to audio/video input jacks on a TV.
 - Making a connection to a PictBridge compliant printer.
- 15** Battery/“Memory Stick Duo” cover
- 16** Battery insertion slot
- 17** “Memory Stick Duo” slot
- 18** Access lamp
- 19** Battery eject lever

Indicators on the screen

Each time you press ▲ (DISP) on the control button, the display changes (page 20).

See the pages in parentheses for details of operation.

When shooting still images

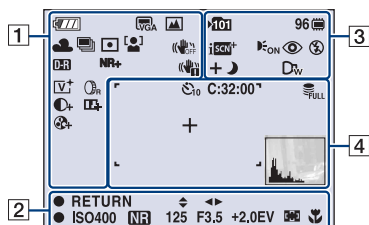

- The indicators are limited in Easy Shooting mode.

When shooting movies

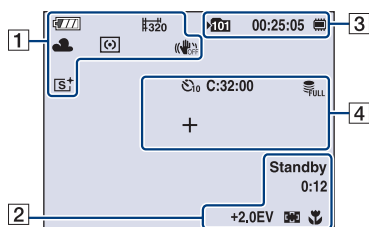

1

| Display | Indication |
|---------|---------------------------------------|
| | Battery remaining |
| | Low battery warning (131) |
| | Image size (49) |
| | Mode dial/Menu (Scene Selection) (28) |

| Display | Indication |
|---------|-------------------------------------------------------------------------------------------------------------------------------------------------------------------------------------------------------------------------------------------------------------------------------------------------------------------------------------------------------------------------------------------------------------|
| P M | Mode dial (23) |
| | White balance (60, 62) |
| | Burst mode/Bracket mode (53) |
| | Metering mode (57) |
| | Face Detection (51)/Smile Detection (52) |
| | SteadyShot (67) <ul style="list-style-type: none"> • In the default setting, when the shutter button is pressed halfway down, one of these indicators appears, depending on the SteadyShot setting. |
| | DRO (63) |
| | Noise Reduction (64) |
| | Vibration warning <ul style="list-style-type: none"> • Indicates vibration may prevent you from shooting clear images due to insufficient lighting. Even if the vibration warning appears, you can still shoot images. However, we recommend that you turn on the anti-blur function, using the flash for better lighting or using a tripod or other means to stabilize the camera (page 8). |
| | Smile Detection Sensitivity indicator/Number of images (32) |
| | Zoom scaling (25, 90) |

| Display | Indication |
|---------|-----------------------|
| | Color mode (64) |
| | Color Filter (65) |
| | Contrast (66) |
| | Sharpness (66) |
| | Color Saturation (66) |

2

| Display | Indication |
|--------------------|------------------------------------------------------------------------------------------------------------------------------------------------------------------------------------------------------------------------------------------------------------|
| | Manual exposure setting mode (34) |
| | Function guide for Manual exposure (34) |
| | Function guide for Manual exposure (34) |
| | AE/AF lock (24) |
| REC Standby | Recording a movie/Standby a movie |
| ISO400 | ISO number (56) |
| NR | NR slow shutter <ul style="list-style-type: none"> When the shutter speed becomes slower than a certain speed in low light conditions, the NR (Noise Reduction) slow shutter function is activated automatically to reduce the image noise. |
| 125 | Shutter speed |
| F3.5 | Aperture value |
| +2.0EV | Exposure Value (55) |
| 0:12 | Recording time (minutes : seconds) |
| | AF range finder frame indicator (58) |
| 1.0m | Semi manual value (59) |
| | Macro (26) |

3

| Display | Indication |
|-----------------|--------------------------------------------------------------------------------------------------------------------------|
| | Recording folder (82) <ul style="list-style-type: none"> This does not appear when using internal memory. |
| 96 | Number of recordable images |
| | Recording Media (“Memory Stick Duo”, Internal memory) |
| 00:25:05 | Recordable time (hours : minutes : seconds) |
| | Scene Recognition (54) |
| | AF illuminator (89) |
| | Red-eye reduction (63) |
| | Flash mode (26) |
| | Flash charging |
| | Conversion lens (91) |

4

| Display | Indication |
|----------------|-------------------------------|
| | Self-timer (27) |
| C:32:00 | Self-diagnosis display (131) |
| | Database full (134) |
| | Spot metering cross hair (57) |
| | AF range finder frame (58) |
| | Histogram (20) |

When playing back still images

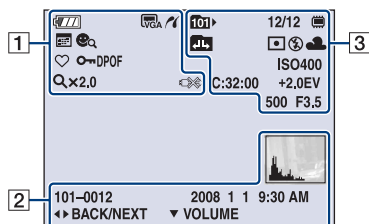

When playing back movies

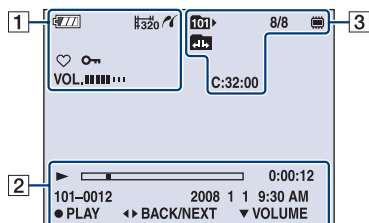



1







| Display | Indication |
|---------------|------------------------------------------------------------------------------------------------------------------|
| | Battery remaining |
| | Low battery warning (131) |
| | Image size (49) |
| | PictBridge connecting (116) |
| | View Mode (68) |
| | Filter by Faces (70) |
| | Favorites (68) |
| | Protect (77) |
| DPOF | Print order (DPOF) mark (118) |
| Qx2.0 | Zoom scaling (36) |
| VOL. ■■■■■■■■ | Volume (36) |
| | PictBridge connecting (117) • Do not disconnect the cable for multi-use terminal while the mark is displayed. |

2

| Display | Indication |
|---------------------|------------------------------------------|
| | Playback (36) |
| | Playback bar |
| 0:00:12 | Counter |
| 101-0012 | Folder-file number (79) |
| 2008 1 1 9:30 AM | Recorded date/time of the playback image |
| ● STOP ● PLAY | Function guide for playing image |
| ◀▶ BACK/ NEXT | Selecting images |
| ▼ VOLUME | Adjusting volume |

| Display | Indication |
|----------------------------------------------------------------------------------|--------------------------------------------------------------------------------------------------------------------------------------------------------------------------------------------------|
|  | Histogram (20) <ul style="list-style-type: none"> •  appears when histogram display is disabled. |

3

| Display | Indication |
|----------------------------------------------------------------------------------------------|---------------------------------------------------------------------------------------------------------------------------|
|  | Playback folder (79) <ul style="list-style-type: none"> • This does not appear when using internal memory. |
| 8/8 12/12 | Image number/Number of images recorded in selected folder |
|  | Playback Media (“Memory Stick Duo”, Internal memory) |
|  | Changing folder (79) <ul style="list-style-type: none"> • This does not appear when using internal memory. |
|  | Metering mode (57) |
|  | Flash |
| AWB  | White balance (60) |
| ISO400 | ISO number (56) |
| C:32:00 | Self-diagnosis display (131) |
| +2.0EV | Exposure Value (55) |
| 500 | Shutter speed |
| F3.5 | Aperture value |

Changing the screen display

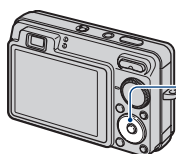

▲ (DISP) (Screen display) button

Each time you press ▲ (DISP) on the control button, the display changes as follows:

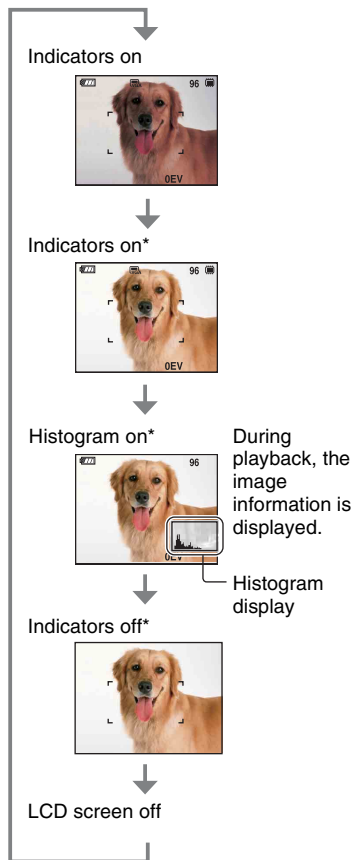

* The brightness of the LCD Backlight is set to up.

- If you view images in bright outside light, adjust the brightness of the LCD backlight up. However, the battery power may decrease faster under such condition.
- The histogram does not appear in the following situations:
 - While shooting
 - When the menu is displayed.
 - When recording movies.
 - During playback
 - When the menu is displayed.
 - In index mode.
 - When you are using playback zoom.
 - When you are rotating still images.
 - During playback of movies.
 - When the Favorites List is displayed.
 - When the Date List is displayed.
- During image playback, you cannot turn the LCD screen off.
- A large difference in the histogram displayed during shooting and playback may occur when:
 - The flash strobes.
 - The shutter speed is slow or fast.
- The histogram may not appear for images recorded using other cameras.
- When you set the LCD screen to off, the digital zoom does not function. When you select (Flash mode)/ (Self-timer)/ (Macro), the image is displayed for about two seconds.
- If you turn the power off and on again while the LCD screen is off, the indicators will be on.

Changing the screen display

💡 Adjusting EV (Exposure Value) by displaying a histogram

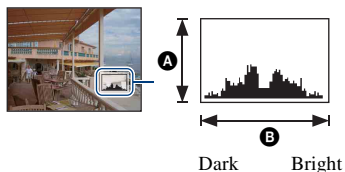

A histogram is a graph showing the brightness of an image. Press ▲ (DISP) on the control button repeatedly to display the histogram on the screen. The graph display indicates a bright image when skewed to the right side, and a dark image when skewed to the left side.

Ⓐ Number of pixels

Ⓑ Brightness

- The histogram also appears when playing back a single-image, but you cannot adjust the exposure.

Using the internal memory

The camera has approximately 15 MB of internal memory. This memory is not removable. Even when there is no “Memory Stick Duo” inserted in the camera, you can record images using this internal memory.

- Movies with the image size set to [640(Fine)] cannot be recorded using the internal memory.

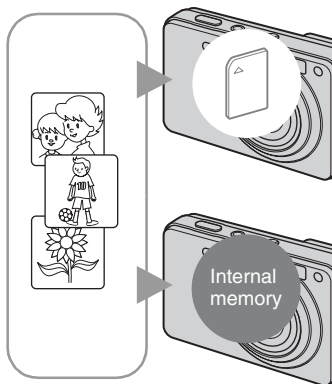

When a “Memory Stick Duo” is inserted

[Recording]: Images are recorded on the “Memory Stick Duo”.

[Playback]: Images on the “Memory Stick Duo” are played back.

[Menu, Settings, etc.]: Various functions can be performed on images on the “Memory Stick Duo”.

When there is no “Memory Stick Duo” inserted

[Recording]: Images are recorded using the internal memory.

[Playback]: Images stored in the internal memory are played back.

[Menu, Settings, etc.]: Various functions can be performed on images in the internal memory.

On image data stored in the internal memory

We recommend that you copy (back up) data without error using one of the following methods.

To copy (back up) data on a “Memory Stick Duo”

Prepare a “Memory Stick Duo” with sufficient free capacity, then perform the procedure explained in [Copy] (page 83).

To copy (back up) data on a hard disk of your computer

Perform the procedure on pages 103, 104 or 107, 108 without a “Memory Stick Duo” inserted in the camera.

- You cannot copy image data on a “Memory Stick Duo” to the internal memory.
- By connecting the camera to a computer with a cable for multi-use terminal, you can copy data stored in the internal memory to a computer. However you cannot copy data on a computer to the internal memory.



Using the mode dial

Set the mode dial to the desired function.

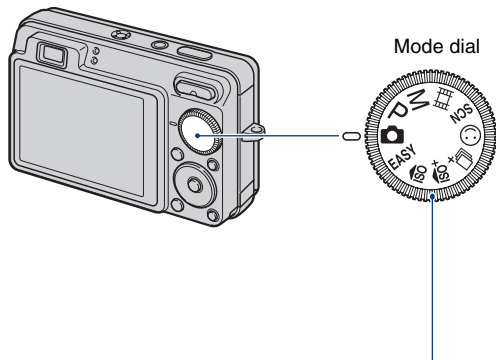

| | |
|--------------|----------------------------------------------------------------------------------------------------------------------------------------------------------------------------------------------|
| | Auto Adjustment mode Allows shooting with the settings adjusted automatically. → page 24 |
| EASY: | Easy Shooting mode Allows you to shoot still images using the minimum necessary functions with easy-to-see indicators. → page 25 |
| P: | Program Auto mode* Allows you to shoot with the exposure adjusted automatically (both the shutter speed and the aperture value). |
| M: | Manual Exposure Shooting mode* Allows you to shoot after adjusting the exposure manually (both the shutter speed and the aperture value). → page 34 |
| | Movie Mode Allows you to record movies with audio. → page 24 |
| | Scene Selection mode Allows you to shoot with preset settings according to the scene. You can select , , , , , , , in the menu when the mode dial is set to SCN. → page 28 |

* You can select various settings using the menu. (For details on the functions available → page 47)

Shooting images (Auto Adjustment mode)

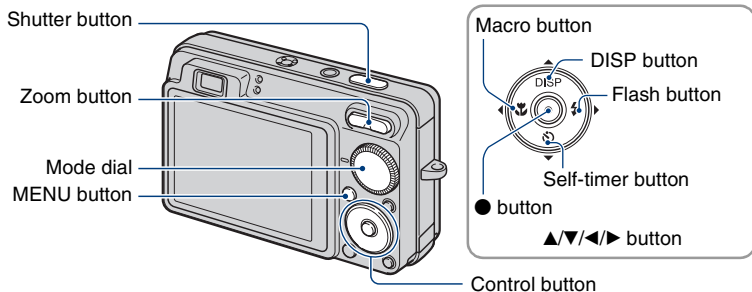

1 Select the desired function from the mode dial.

When shooting still images (Auto Adjustment mode): Select .

When shooting movies: Select .

2 Hold the camera, with your elbows pressed against your body to steady it.



Position the subject in the center of the focus frame.

3 Shoot with the shutter button.

When shooting still images:

- ① Press and hold the shutter button halfway down to focus.

The ● (AE/AF lock) indicator (green) flashes, a beep sounds, the indicator stops flashing and remains lit.



AE/AF lock indicator

- ② Press the shutter button fully down.

When shooting movies:

Press the shutter button fully down.

To stop recording, press the shutter button fully down again.

If you shoot a still image of a subject that is difficult to focus on

- The shortest shooting distance is approximately 5 cm (2 inches) (W)/34 cm (1 foot 1 1/2 inches) (T) (from the front of the lens).
- When the camera cannot focus on the subject automatically, the AE/AF lock indicator changes to flash slowly and the beep does not sound. In addition, the AF range finder frame disappears. Recompose the shot and focus again.

Focusing may be difficult in the following situations:

- It is dark and the subject is distant.
- The contrast between the subject and the background is poor.
- The subject is seen through glass.
- The subject is moving quickly.
- There is reflective light or shiny surfaces.
- The subject is backlit or there is a flashing light.

EASY Shooting in Easy Shooting mode

Set the mode dial to **EASY**.

The text size increases and indicators become easier to see.

The camera shoots images with the optimum settings, so the only settings that you can change are Image Size (Large/Small) (page 50), Flash (Auto/Off) (page 50) and Self-Timer (10 sec/Off) (page 27).

- Backlight becomes bright automatically, and battery consumption is faster.

W/T Using the zoom

Press **T** to zoom, press **W** to undo the zoom.

- When the zoom scale exceeds 3×, the camera uses the Digital Zoom function.
For details on the [Digital Zoom] settings and the image quality, see page 90.
- You cannot change the zoom scale while shooting a movie.

⚡ Flash (Selecting a flash mode for still images)

Press ► (⚡) on the control button repeatedly until the desired mode is selected.



(No indicator): Flash Auto

Flashes when there is insufficient light or backlight (default setting).

⚡: Flash forced on

⚡sl: Slow synchro (Flash forced on)

The shutter speed is slow in a dark place to clearly shoot the background that is out of flash light.

⊗: Flash forced off

- The flash strobos twice. The first flash adjusts the light quantity.
- While charging the flash, ⚡ is displayed.

🌸 Macro (Shooting close-up)

Press ◀ (🌸) on the control button repeatedly until the desired mode is selected.



(No indicator): Auto

The camera adjusts the focus automatically from distant subjects to close-up.

Normally, put the camera in this mode.



🌸: Macro

The camera adjusts the focus with priority on close-up subjects.

Set Macro On when shooting close subjects.

- The Auto Focus speed drops during shooting distant subjects when the Macro is set to on.
- Setting the zoom all the way to the W side is recommended.

Using the self-timer

Press  () on the control button repeatedly until the desired mode is selected.





(No indicator): Not using the self-timer

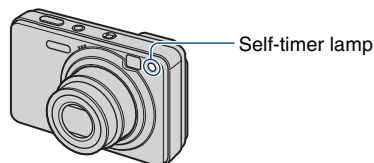

: Setting the 10-second delay self-timer

: Setting the 2-second delay self-timer

When you press the shutter button, the self-timer lamp flashes and a beep sounds until the shutter operates.



To cancel, press  () again.

- Use the 2-second delay self-timer to prevent blur of an image. The shutter is released 2 seconds after you press the shutter button, which reduces camera shake when the shutter button is pressed.
- In Easy Shooting mode, you can select only  (10 sec) or  (Off).

Shooting still images (Scene Selection)

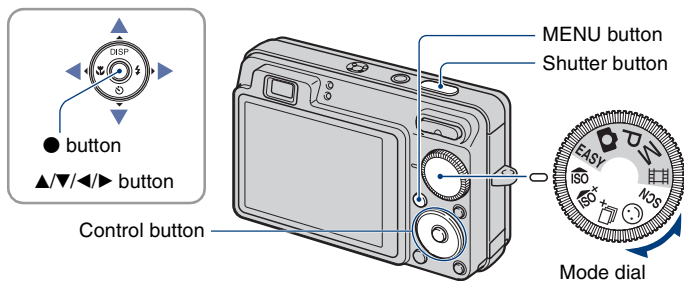

Select the mode (iSo/iSo+/i/☺/SCN) in the mode dial

1 Select the desired mode of Scene Selection (iSo/iSo+/i/☺/SCN) with the mode dial.

2 Shoot with the shutter button.

Select the mode (i/👤/🏠/👤/🌙/🏞️/🌊/🌅/🌅) in SCN

1 Select SCN with the mode dial.

2 Press the MENU button, and select from i/👤/🏠/👤/🌙/🏞️/🌊/🌅/🌅 with ▲/▼/◀/▶ on the control button (page 49).

3 Shoot with the shutter button.

• For details on the mode, see next page.

To cancel the Scene selection

Set the mode dial to anything other than the Scene Selection mode.

Scene Selection modes

The following modes are preset to match the scene conditions.

Modes selected from the mode dial



High Sensitivity

Allows you to shoot images without a flash under low light conditions, reducing blur.



Extra High Sensitivity

Allows you to shoot bright images without a flash in dark places where hand shake tends to occur even when the  (High Sensitivity) mode is activated. The image size is set to [3M].



Extra High-speed Burst

Allows you to shoot maximum 5 frames per second in extra high-speed burst. The recording interval is approximately 0.2 seconds.
The image size is set to [3M].



Smile Shutter

When the camera detects a smile, the shutter is released automatically. For details, see page 32.

Modes selected from the menu screen



Soft Snap

Allows you to shoot images with a softer atmosphere for portraits and flowers, etc.

Shooting still images (Scene Selection)



Landscape

Focuses only on a distant subject to shoot landscapes, etc.



Twilight Portrait*

Allows you to shoot sharp images of people with the night view in the background without compromising the atmosphere.



Twilight*

Allows you to shoot night scenes at far distance without losing the dark atmosphere of the surroundings.



Beach

Allows you to record the blue of the water clearly when shooting seaside or lakeside scenes.



Snow

Allows you to record clear images preventing sunken colors in snowy scenes or other places where the whole screen appears white.





Fireworks*

Allows you to record fireworks in all their splendor.



Underwater























Allows you to shoot underwater in natural colors when using a water proof housing.

* When you shoot images using  (Twilight Portrait),  (Twilight) or  (Fireworks) mode, the shutter speed becomes slower, and blurring occurs frequently, so use of a tripod is recommended.

Functions you can use in Scene Selection

For shooting an image appropriately according to the scene condition, a combination of functions is determined by the camera. Some functions are not available, depending on the Scene Selection mode.

(✓: you can select the desired setting)

| | Macro | Flash | Face Detection | Smile Detection | Smile Detection Sensitivity | Burst/Bracket | White Balance | Red Eye Reduction | Self-Timer |
|------------------------------------------------------------------------------------|-------|-----------------------------------------------------------------------------------------|-----------------|-----------------|-----------------------------|---------------|------------------------------------------------------------------------------------------------------|-------------------|-----------------|
|  | ✓ |  | ✓ | — | — | — | √ ^{*1} | — | ✓ |
|  | ✓ |  | ✓ | — | — | — | √ ^{*1} | — | ✓ |
|  | ✓ |  | ✓ | — | — | — | √ ^{*1} | — | √ ^{*2} |
|  | ✓ | ✓ | — | ✓ | ✓ | — | — | — | — |
|  | ✓ | ✓ | √ ^{*3} | — | — | ✓ | — | ✓ | ✓ |
|  | — | ⚡ /  | — | — | — | ✓ | — | ✓ | ✓ |
|  | ✓ | ⚡ SL | ✓ | — | — | — | — | ✓ | ✓ |
|  | — |  | — | — | — | — | — | — | ✓ |
|  | ✓ | ⚡ /  | ✓ | — | — | ✓ | — | ✓ | ✓ |
|  | ✓ | ⚡ /  | ✓ | — | — | ✓ | — | ✓ | ✓ |
|  | — |  | — | — | — | — | — | — | ✓ |
|  | ✓ | ⚡ /  | — | — | — | ✓ | WB  ^{*4} | — | ✓ |

*1) [Flash] for [White Balance] cannot be selected.

*2) When recording with the self-timer, a series of up to five images is recorded.

*3) [Off] for [Face Detection] cannot be selected.

*4) You can use [Underwater White Balance] instead of [White Balance].

Shooting in Smile Shutter mode

When the camera detects a smile, the shutter is released automatically.

- ① Select ☺ (Smile Shutter) mode from the mode dial.
- ② Press the shutter button halfway down to adjust the focus while aiming the camera at the subject to be shoot.
- ③ Press the shutter button all the way down.
The Smile Shutter enters standby.

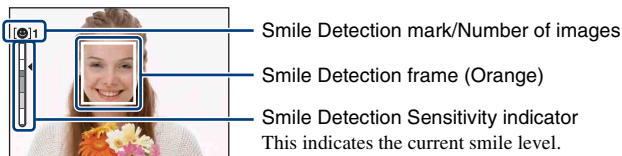

Each time the smile level reaches the set Smile Detection Sensitivity (indicated by ◀), the camera automatically operates the shutter and records up to six images. After recording the image, the Smile Shutter lamp lights (page 14).

- ④ Press the shutter button all the way down again to exit the Smile Shutter mode.
- When the Smile Shutter is in standby, the Record lamp (Orange) flashes.
 - Shooting using the Smile Shutter ends automatically when either the “Memory Stick Duo” or internal memory becomes full or when six images have been recorded.
 - You can select the subject that has priority for smile detection with [Smile Detection] (page 52).
 - If a smile is not detected, set the [Smile Detection Sensitivity] (page 52).
 - You can have the camera shoot the image automatically when any person displayed in the smile detection frame (Orange) smiles after pressing the shutter button all the way down.
 - The image may not be in focus if the distance between the camera and the subject is changed after pressing the shutter button all the way down. The suitable exposure may not be obtained if the surrounding brightness changes.
 - Faces may not be detected correctly when:
 - It is too dark or too bright.
 - Faces are partially hidden by sunglasses, masks, hats, etc.
 - The subjects are not facing the camera.
 - Smiles may not be detected correctly depending on the conditions.
 - You cannot use the Digital Zoom function.
 - You cannot change the zoom ratio when the Smile Shutter is in standby.

💡 Hints for better capturing of smiles

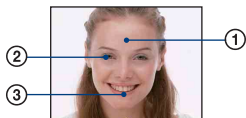

- ① Do not cover the eyes with the bangs.
- ② Try to orient the face in front of the camera and be as level as possible. The detection rate is higher when the eyes are narrowed.
- ③ Give a clear smile with an open mouth. The smile is easier to detect when the teeth are showing.

Shooting with the manual exposure

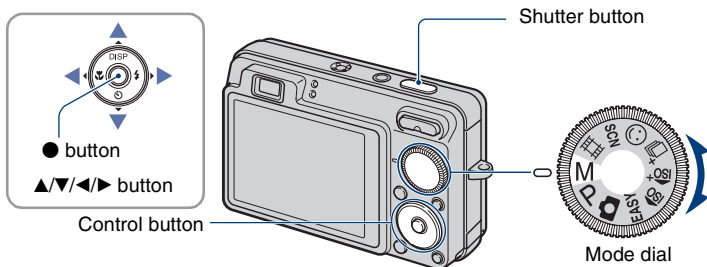

1 Select M from the mode dial and press ● on the control button.

- [SET] changes to [RETURN] on the lower left of the screen and the camera is set to manual exposure setting mode.

2 Adjust the exposure manually using the control button.

◀/▶: Aperture (F value)

▲/▼: Shutter speed

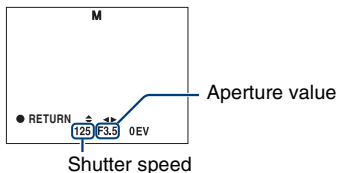

- Select an aperture value from below.
 - When the zoom is set fully to the W side, you can select an aperture F2.8, F5.6 or F8.0 (using the internal ND filter).
 - When the zoom is set fully to the T side, you can select an aperture F5.5, F11 or F16 (using the internal ND filter).
- You can select a shutter speed from 30 to 1/1000 seconds.
The difference between the settings and proper exposure judged by the camera appears as an EV value (page 55) on the screen. 0EV indicates the value judged as the most suitable by the camera.

3 Shooting with the shutter button.

- To select a flash mode, shoot in Macro mode/self-timer mode, or change the screen display mode, press ● to cancel Manual Exposure Shooting mode ([RETURN] changes to [SET] on the screen.).
- The flash is set to (Flash On) or (Flash Off).
- Shutter speeds of one second or longer are indicated by ["], for example, [1"].

Shooting with the manual exposure

- When you set the shutter speed slower, using a tripod is recommended to prevent the effects of vibration.
- When the shutter speed becomes slower than a certain speed, the NR slow shutter function is activated automatically to reduce the picture noise, and **NR** appears on the bottom of the screen.
- If you select slow shutter speeds, it takes time to process the data.

Viewing images

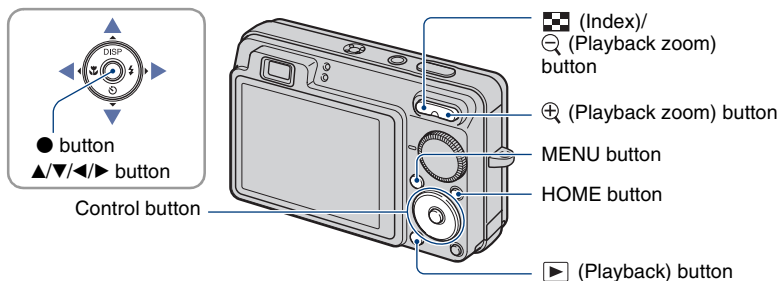

1 Press the ▶ (Playback) button.

- If you press the ▶ (Playback) button when the camera is powered off, the camera is turned on automatically and set to playback mode. To switch to the shooting mode, press the ▶ (Playback) button again.

2 Select an image with ◀/▶ on the control button.

Movie:

Press ● to play back a movie. (Press ● again to stop playback.)

Press ▶ to fast forward, ◀ to rewind. (Press ● to return to normal playback.)

Press ▼ to display the volume control screen, then press ◀/▶ to adjust the volume.

- Movies of image size [320] are displayed in a smaller size.

- Sometimes images shot using earlier Sony models cannot be played back. Press the HOME button, select [Folder View] from [View Images], then play back the images.

⌂/⊕ To view an enlarged image (playback zoom)

Press ⊕ while displaying a still image. To undo the zoom, press ⌂.

Adjust the position with ▲/▼/◀/▶.

To cancel the playback zoom, press ●.

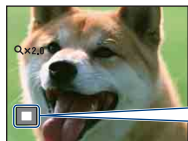





Shows the displayed area of the whole image. In this case, the center is enlarged.

- To store enlarged images, see [Trimming] (page 72).





❑ To view an index screen

Press  (Index) to display the index screen while a still image is displayed.

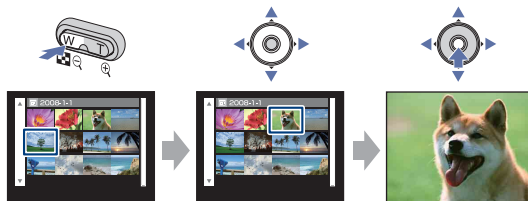
Select an image with ///.

To return to the single-image screen, press .



- In the default setting, images are displayed in Date View (when using the “Memory Stick Duo”) or in Folder View (when using the internal memory). You can change the View Mode by selecting  (View Images) on the HOME screen when using the “Memory Stick Duo” (page 68).
- Each time you press  (Index), the number of images on the index screen increases.
- When using a “Memory Stick Duo”, you can select the desired date/folder with / after selecting the bar with .

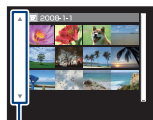

Bar

Viewing still images as a slideshow

Still images are played back sequentially with music and effects added.

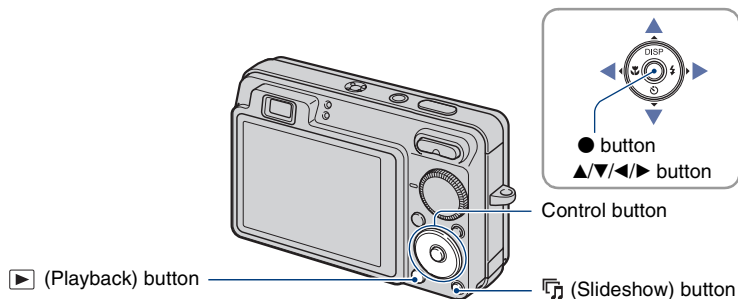

1 Press the (Slideshow) button.

The setup screen appears.

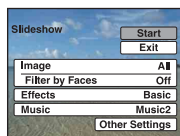

2 Press the (Slideshow) button again.

The slideshow starts.

- You cannot play movies.
- Settings other than [Image] and [Filter by Faces] are stored until the next time they are changed.
- Sometimes the [Filter by Faces] function cannot be used with images shot using earlier Sony models.

To end the slideshow

Press the  (Slideshow) button.

- You cannot pause the slideshow.

To adjust the volume of the music

Press ▼ to display the volume control screen, and then press ◀/▶ to adjust the volume.

To change the setup

On the setup screen in step 1, select each item with ▲/▼, then press ●.

The items that can be set are as follows.

The default settings are marked with ✓.

| Image | | |
|-------------------------------------------------------------------------------------------|---------------|--------------------------------------------------------------------------------------------------------------------------------------------------------------------------------------------------------------------------------------|
| This setting is fixed to [Folder] if a “Memory Stick Duo” (not supplied) is not inserted. | | |
| ✓ | All | Plays back all the still images in order. |
| | Folder | Plays back the still images in the selected folder, of the selected date, or in Favorites. <ul style="list-style-type: none"> • [Folder] and [This date] can only be selected when using the associated View Mode. |
| | This date | |
| | Favorites 1-6 | |

| Filter by Faces | | |
|----------------------------------------------------------------------------------------|------------|-----------------------------------------------------------------------------------------------------------------------------------------------------------------------------------------------------------------------------------------------------------------|
| This setting is fixed to [Off] if a “Memory Stick Duo” (not supplied) is not inserted. | | |
| ✓ | Off | Does not filter images. |
| | All people | Displays images filtered by the selected conditions. <ul style="list-style-type: none"> • Sometimes images are mistakenly displayed or hidden. • Sometimes filtering cannot be performed with images shot using earlier Sony models. |
| | Children | |
| | Infants | |
| | Smiles | |

Viewing still images as a slideshow

| Effects | | |
|---------|------------------|-------------------------------------------------------------------------------------------------------------------------------------------------------------------------------------------------------------------------|
| | Simple | A simple slideshow switching still images at a preset interval <ul style="list-style-type: none"> The playback interval is adjustable. This effect allows you to enjoy your images at your own set pace. |
| ✓ | Basic | A basic slideshow suitable for a wide range of scenes |
| | Nostalgic | A moody slideshow reproducing the atmosphere of a movie scene |
| | Stylish | A stylish slideshow proceeding at a middle tempo |
| | Active | A high-tempo slideshow suitable for active scenes |
| | Face 1:Basic | Delivers a mid-tempo slideshow, with effects such as zooming in on faces and displaying multiple images side-by-side. Suitable for various scenes bringing out the best of images that include faces |
| | Face 2:Nostalgic | A slower, more emotive slideshow, with effects such as zooming in on faces and displaying multiple images side-by-side, to bring out the best of images that include faces |
| | Face 3:Stylish | A lively, high tempo slideshow, with effects such as zooming in on faces and displaying multiple images side by side, to bring out the best of images that include faces |

| Music | | |
|-----------------------------------------------------------------------------------------------------------------------------------------------------------------------------------------------------------------------|--------|--------------------------------------------------------|
| The music played is determined by default according to the effect you select. You can custom set any music with any effect as desired. It is also possible to choose from multiple background music (BGM) selections. | | |
| | Music1 | The default setting for a [Simple] slideshow |
| ✓ | Music2 | The default setting for a [Basic] slideshow |
| | Music3 | The default setting for a [Nostalgic] slideshow |
| | Music4 | The default setting for a [Stylish] slideshow |
| | Music5 | The default setting for a [Active] slideshow |
| | Music6 | The default setting for a [Face 1:Basic] slideshow |
| | Music7 | The default setting for a [Face 2:Nostalgic] slideshow |
| | Music8 | The default setting for a [Face 3:Stylish] slideshow |
| | Off | Does not use Music. |
| | Back | Returns to the setup screen. |

| Other Settings | | |
|--------------------------------------------------------------------------------|--------|-----------------------------------------------------------------|
| Interval | | |
| The setting is fixed to [Auto] when [Simple] is not selected as the [Effects]. | | |
| <input type="checkbox"/> | 1 sec | Sets the display interval of images for a [Simple] slideshow. |
| <input type="checkbox"/> | 3 sec | |
| <input type="checkbox"/> | 5 sec | |
| <input type="checkbox"/> | 10 sec | |
| <input checked="" type="checkbox"/> | Auto | The interval is set to suit the selected [Effects] item. |
| Repeat | | |
| <input checked="" type="checkbox"/> | On | Plays back images in a continuous loop. |
| <input type="checkbox"/> | Off | After all the images have been played back, the slideshow ends. |

To add /change Music files

You can transfer a desired music file from your CDs or MP3 files to the camera to playback during slideshow. You can transfer music using [🎵 Music Tool] in [🎵 (Slideshow)] on the HOME screen and the "Music Transfer" software (supplied) installed on a computer. For details, see pages 110 and 112.

- You can record up to eight pieces of music on the camera (The eight preset pieces (Music1 - Music8) can be replaced with the ones you transferred).
- A maximum length of each music file for music playback of the camera is about 5 minutes.
- If you cannot play back a music file due to damage or other malfunctions to the file, execute [Format Music] (page 110) and transfer the music again.

Deleting images

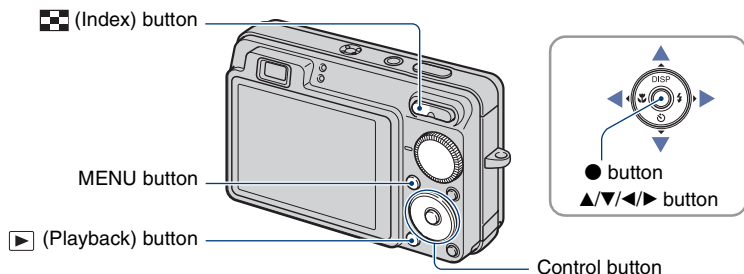

1 Press the  (Playback) button.

2 Press the MENU button while displaying in single-image or index mode.

3 Select  [Delete] with / on the control button.



4 Select the desired deletion method with / from among [This Image], [Multiple Images] and [All Images in Date Range]/[All In This Folder], then press .

- The displayed options vary depending on the selected View Mode (page 68).

When you select [This Image]

You can delete the selected image.
Select [OK] with ▲, then press ●.

When you select [Multiple Images]

You can select and delete multiple images simultaneously.

- ① Select the images you want to delete, then press ●.
The ✓ mark is checked in the checkbox of the image.

Single-Image



Index Display



- ② Press the MENU button.
 - ③ Select [OK] with ▲, then press ●.
- To delete all the images of a date/folder, select [Multiple Images] on the index screen, select the bar with ◀ and place a ✓ mark in the check box.

When you select [All Images in Date Range]/[All In This Folder]

You can delete all the images of the selected date/folder.
Select [OK] with ▲, then press ●.

Learning the various functions – HOME/Menu

Using the HOME screen

The HOME screen is the gateway screen for all the functions of the camera, and can be called up regardless of the mode setting (shooting/viewing).

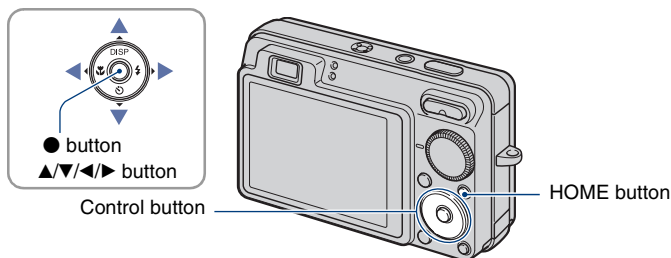

1 Press the HOME button to display the HOME screen.

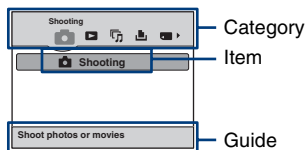







2 Select a category with ◀/▶ on the control button.

3 Select an item with ▲/▼, then press ●.

- You cannot display the HOME screen when a PictBridge connection or a USB connection is made.
- The camera is set to the shooting or viewing mode by pressing the HOME button again.

HOME items

Pressing HOME displays the following items. Only the available items are displayed on the screen. Details on each item are displayed in the guide at the bottom of the screen.

| Categories | Items |
|------------------------------------------------------------------------------------------------|-------------------------------------------------------------------------------------------------------------------------------------------------------------------------------------------------------------------------------------------------------------------------------------------------------------------------------------------------------------------------------------------------------------------------------------------------------------------|
|  Shooting* | Shooting (page 23) |
|  View Images | Date View (page 68) Folder View (page 68) Favorites (page 68) |
|  Slideshow | Slideshow (page 38) Music Tool (page 110) Download Music Format Music |
|  Print | Print (page 115) |
|  Manage Memory | Memory Tool Memory Stick Tool (page 82) Format Change REC.Folder Create REC.Folder Copy Internal Memory Tool (page 84) Format |
|  Settings | Main Settings Main Settings 1 (page 85) Beep Initialize Function Guide Smile demo mode Main Settings 2 (page 87) USB Connect Video Out COMPONENT Wide Zoom Display Shooting Settings Shooting Settings 1 (page 89) AF Illuminator AF Mode Grid Line Digital Zoom Conversion Lens Shooting Settings 2 (page 92) Auto Orientation Auto Review Clock Settings (page 93) Language Setting (page 94) |

* Shooting mode selected with the mode dial will be applied.

Using the menu items

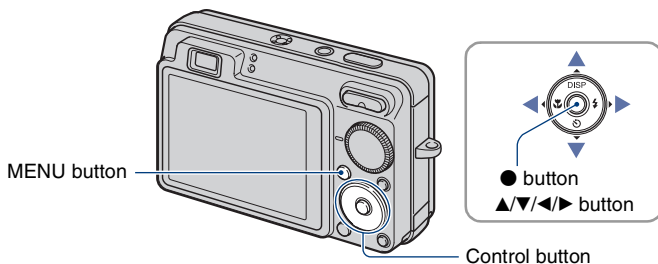

1 Press the MENU button to display the menu.

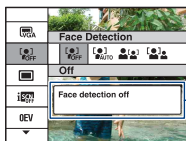

Function Guide

Setting [Function Guide] to [Off] turns off the function guide (page 85).

- The menu will be displayed only during shooting and playback mode.
- Different items will become visible depending on the selected mode.

2 Select a desired menu item with ▲/▼ on the control button.

- If the desired item is hidden, keep pressing ▲/▼ until the item appears on the screen.

3 Select a setting with ◀/▶.

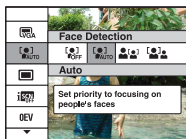

- If the desired setting is hidden, keep pressing ◀/▶ until the setting appears on the screen.
- Select an item in playback mode, and press ●.



4 Press the MENU button to turn off the menu.

Menu items

The available menu items vary depending on the mode setting (shooting/viewing), and the mode dial position in the shooting mode. Only the available items are displayed on the screen.

(✓: available)

Mode dial position:

| | | | | | |
|-----------------------------------------------------------------------------------|------|---|---|-------|-----------------------------------------------------------------------------------|
|  | EASY | P | M | Scene |  |
|-----------------------------------------------------------------------------------|------|---|---|-------|-----------------------------------------------------------------------------------|

Shooting menu (page 49)

| | | | | | | |
|---------------------------------------------------------------------------------------------------------|---|-----|---|---|-----|---|
| Scene Selection | — | — | — | — | ✓*2 | — |
| Image Size | ✓ | ✓*1 | ✓ | ✓ | ✓*2 | ✓ |
| Flash | — | ✓*1 | — | — | — | — |
| Face Detection | ✓ | — | ✓ | ✓ | ✓*2 | — |
| Smile Detection | — | — | — | — | ✓*2 | — |
| Smile Detection Sensitivity | — | — | — | — | ✓*2 | — |
| REC Mode | ✓ | — | ✓ | ✓ | ✓*2 | — |
| Scene Recognition | ✓ | — | — | — | — | — |
| EV | ✓ | — | ✓ | — | ✓ | ✓ |
| ISO | — | — | ✓ | ✓ | ✓*2 | — |
| Metering Mode | — | — | ✓ | ✓ | ✓*2 | ✓ |
| Focus | — | — | ✓ | ✓ | ✓*2 | ✓ |
| White Balance | — | — | ✓ | ✓ | ✓*2 | ✓ |
| Underwater White Balance | — | — | — | — | ✓*2 | — |
| Flash Level | — | — | ✓ | ✓ | — | — |
| Red Eye Reduction | ✓ | — | ✓ | ✓ | ✓*2 | — |
| DRO | — | — | ✓ | ✓ | — | — |
| Noise Reduction | — | — | ✓ | ✓ | — | — |
| Color Mode | — | — | ✓ | ✓ | ✓*2 | ✓ |
| Color Filter | — | — | ✓ | ✓ | ✓*2 | — |
| Color Saturation | — | — | ✓ | ✓ | ✓*2 | — |
| Contrast | — | — | ✓ | ✓ | ✓*2 | — |
| Sharpness | — | — | ✓ | ✓ | — | — |
| SteadyShot | — | — | ✓ | ✓ | ✓ | ✓ |
|  (Shooting Settings) | ✓ | — | ✓ | ✓ | ✓ | ✓ |

*1) The items that can be selected are limited compared to other modes (page 25).

*2) The operation is limited according to the selected Scene Selection mode (page 31).

Viewing menu (page 69)

 (Delete)

 (Date List)

 (Add / Remove Favorites)

 (Retouch)

 (Protect)

 (Print)

 (Select Folder)

 (View Mode)

 (Filter by Faces)

 (Slideshow)

 (Multi-Purpose Resize)

DPOF

 (Rotate)



The functions in shooting mode using MENU are described below.
For details on how to operate the menu, see page 46.

The selectable mode is displayed in white.

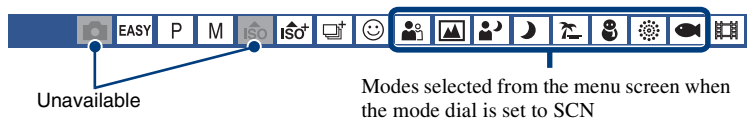

The default settings are marked with ✓.

Scene Selection: Selecting the Scene Selection



Selects the Scene Selection in the menu.

You can shoot images with the settings pre-adjusted to match various scene conditions (page 28).

Image Size: Selecting the image size



For details, see page 11.

For still images

| | | |
|---|--|-----------------------------------------------|
| ✓ | | Selects image size for shooting still images. |
| | | |
| | | |
| | | |
| | | |
| | | |
| | | |
| | | |



- [Image Size] is fixed to [3M] when the ISO^+ (Extra High Sensitivity) mode or (Extra High-speed Burst) mode is selected in the scene selection.

For Easy Shooting mode

Selects the still image size for Easy Shooting mode.

| | | |
|-------------------------------------|-------|------------------------------|
| <input checked="" type="checkbox"/> | Large | Shoots images in [13M] size. |
| <input type="checkbox"/> | Small | Shoots images in [3M] size. |

For movie

| | | |
|-------------------------------------|--------------------------------------------------------------------------------------------------|------------------------------------------|
| <input type="checkbox"/> |  FINE (Fine) | Selects image size for recording movies. |
| <input checked="" type="checkbox"/> |  STD (Standard) | |
| <input type="checkbox"/> |  320 | |

Flash: Flash setting

Selects the flash setting in Easy Shooting mode.





| | | |
|-------------------------------------|------|--------------------------------------------------------------|
| <input checked="" type="checkbox"/> | Auto | Flash strobos when there is insufficient light or backlight. |
| <input type="checkbox"/> | Off | Does not use the flash. |



Face Detection: Detecting the face of subject



Selects whether to use the Face Detection function or not, and also selects the priority subject for adjusting the focus when using the function.

Detects the faces of your subjects and adjusts the focus, flash, exposure, white balance and red-eye reduction settings automatically.



| | | |
|---|----------------------------------------------------------------------------------------------------|------------------------------------------------------------------------------------------------------------------------------------------------|
| ✓ |  (Off) | Does not use Face Detection function. |
| |  (Auto) | Selects the face the camera is to automatically focus on.  |
| |  (Child Priority) | Focuses with priority on children's faces. |
| |  (Adult Priority) | Focuses with priority on adults' faces. |

- The Face Detection function does not work when using the digital zoom.
- When the Scene Selection mode is set to  (Soft Snap) mode, the Face Detection function is activated.
- When the Scene Selection mode is set to  (Soft Snap) mode, the default setting of [Face Detection] is [Auto].
- Although [Face Detection] is fixed to [Auto] when Easy Shooting mode is selected, no face detection frames are displayed.
- Up to 8 faces of your subjects can be detected. However, only up to 4 faces of your subjects can be detected when  (Soft Snap) mode is selected in the Scene Selection mode.
- When the camera detects more than one subject, the camera will judge which is the main subject and set focus by priority. The Face Detection frame for the main subject will turn orange.
- The frame for which the focus is set will turn green by pressing the shutter button halfway down.
- Faces may not be detected correctly when:
 - It is too dark or too bright.
 - Faces are partially hidden by sunglasses, masks, hats, etc.
 - The subjects are not facing the camera.
- Adults and children may not be recognized correctly depending on the conditions.

Smile Detection: Setting the Smile Detection function



Selects the priority subject for the Smile Shutter function. For details on the Smile Shutter, see page 32.



| | | |
|-------------------------------------|----------------------------------------------------------------------------------------------------|---------------------------------------------------|
| <input checked="" type="checkbox"/> |  (Auto) | Detects and shoots smiling faces automatically. |
| <input type="checkbox"/> |  (Child Priority) | Detects and shoots with priority on child's face. |
| <input type="checkbox"/> |  (Adult Priority) | Detects and shoots with priority on adult's face. |

- Smiles may not be detected correctly depending on the conditions.

Smile Detection Sensitivity: Setting the Smile Detection Sensitivity



This sets the smile detection level using the Smile Shutter function. For details on the Smile Shutter, see page 32.







| | | |
|-------------------------------------|--------------------------------------------------------------------------------------------|------------------------------|
| <input type="checkbox"/> |  (Low) | Detects a big smile. |
| <input checked="" type="checkbox"/> |  (Medium) | Detects a normal smile. |
| <input type="checkbox"/> |  (High) | Detects even a slight smile. |

- Smiles may not be detected correctly depending on the conditions.

REC Mode: Selecting the continuous shooting method



Selects whether the camera performs continuous shooting or not when you press the shutter button.

| | | |
|-------------------------------------|--------------------------------------------------------------------------------------------|---------------------------------------------------------------------------------------------------------------------------------------------------------------------------------------------------------------------------------------------------------------------------------------------------------------------------------------------------------------------------------------------------------------------------------------------------------------------------------------------------------------------------------------------------------------------------------------------------------------------------------------------------------------------------------------------------------------------------------------------------------------------------------------------------------------------------------------------------------|
| <input checked="" type="checkbox"/> |  (Normal) | Does not shoot continuously. |
| <input type="checkbox"/> |  (Burst) | <p>Records 100 images in succession when you press and hold down the shutter button.</p>  <ul style="list-style-type: none"> The flash is set to  (Flash forced off). |
| <input type="checkbox"/> | BRK $\pm 0.3\text{EV}$ | <p>Records a series of three images with the exposure values automatically shifted (Exposure Bracket). The larger the bracket step value, the larger the shift of the exposure value.</p> <ul style="list-style-type: none"> When you cannot decide the correct exposure, shoot in the Exposure Bracket mode, shifting the exposure value. You can select the image with the best exposure afterward.  <ul style="list-style-type: none"> When the mode dial is set to , the Exposure Bracket mode is not available. The flash is set to  (Flash forced off). |
| <input type="checkbox"/> | BRK $\pm 0.7\text{EV}$ | |
| <input type="checkbox"/> | BRK $\pm 1.0\text{EV}$ | |

On the Burst

- When recording with the self-timer, a series of a maximum of five images is recorded.
- When recording in burst with the mode dial set to **M**, you cannot select a shutter speed of 1/3 seconds or slower.
- The recording interval is approximately 0.5 seconds. The recording interval becomes longer, depending on the setting for the image size.
- When the battery level is low, or when the internal memory or "Memory Stick Duo" is full, the Burst stops.
- The focus, white balance, and exposure are adjusted for the first image, and these settings are also used for the other images.

On the Exposure Bracket



- The focus and white balance are adjusted for the first image, and these settings are also used for the other images.
- When recording in burst with the mode dial set to **M**, you cannot select a shutter speed of 1/3 seconds or slower.
- When you adjust the exposure manually (page 55), the exposure is shifted based on the adjusted brightness.

- The recording interval is the same as the Burst mode. The recording interval may be longer, depending on the scene conditions.
- If the subject is too bright or too dark, you may not be able to shoot properly with the selected bracket step value.

Scene Recognition: Determining the scene to be shot and taking the shot







The camera automatically detects shooting conditions, such as backlight or a night scene, and then takes the shot.

| | | |
|---|------------------------------------|------------------------------------------------------------------------------------------------------------------------------------------------------------------------------------------------------------------------------------------------------------------------------------------------------------------------------------------------------------------------------------------------------------------------------------------------------------------------------------------------------------------------------------------------------------------------------|
| ✓ | iSCN_{OFF} (Off) | Does not use the Scene Recognition. |
| | iSCN (Auto) | <p>The camera detects conditions such as backlight or a night scene and takes the shot using the optimal settings. If the camera does not recognize the scene, it shoots the image just as if scene recognition was set to [Off].</p> <div data-bbox="414 594 609 739" style="text-align: center;"> </div> <p data-bbox="647 601 885 652">  Current setting mark  Scene Recognition mark </p> |
| | iSCN⁺ (Advanced) | <p>The camera shoots one image without using the scene recognition function and another image using scene recognition. + is displayed next to a scene recognition mark. (A total of two shots)</p> <p>If the camera does not recognize the scene, it only shoots one image.</p> <p>In this case, the image is shot just as if scene recognition was set to [Off].</p> |







About Scenes that Are Recognized

The following scenes can be recognized. The camera identifies the optimum scene and displays each mark.

When the shutter is pressed halfway down while a mark is displayed, the mark color turns green and scene recognition is confirmed.

-  Twilight
-  Twilight Portrait
-  Twilight using a tripod
-  Backlight
-  Backlight Portrait

- Scene recognition does not function in the following situations:
 - During burst shooting
 - When using digital zoom

- The flash is set to  AUTO (Flash Auto) or  (Flash forced off).
- When the Face Detection function is set to [Off] and [Scene Recognition] is set to [Auto] or [Advanced], the setting of [Face Detection] is changed to [Auto].
- When the Face Detection function is [Off],  (Twilight Portrait) and  (Backlight Portrait) scenes cannot be detected.
-  (Twilight using a tripod) scenes sometimes cannot be recognized in an environment where vibrations are transferred to the camera even though it is fixed on a tripod.
- Sometimes a slow shutter results when a scene is recognized as a  (Twilight using a tripod). Make sure to keep the camera still during shooting.
- The current setting mark and scene recognition mark are displayed regardless of the screen display settings (page 20).
- Sometimes these scenes may not be recognized depending on the situation.

EV: Adjusting the light intensity



Manually adjusts the exposure.



Toward -



Toward +

| | | |
|---|--------|---------------------------------------------------------|
| | -2.0EV | Toward -: Darkens an image. |
| ✓ | 0EV | The exposure is determined automatically by the camera. |
| | +2.0EV | Toward +: Brightens an image. |

- For details on the Exposure, see page 9.
- For details on the exposure setting of the Manual Exposure Shooting mode, see page 34.
- The compensation value can be set in 1/3EV increments.
- If you shoot a subject in extremely bright or dark conditions, or when you use the flash, the exposure adjustment may not be effective.

ISO: Selecting a luminous sensitivity



Selects the ISO sensitivity.





Low ISO sensitivity



High ISO sensitivity



| | | |
|-------------------------------------|-----------------|-------------------------------------------------------------------------------------------------------------------------------------------------------------------------------------------------------------------------------------------------------------------------------|
| <input checked="" type="checkbox"/> | ISO AUTO (Auto) | You can reduce image blurring in dark locations or moving subjects by increasing ISO sensitivity (select a larger number). However, images tend to become noisier as the ISO sensitivity number increases. Select an ISO sensitivity number according to shooting conditions. |
| <input type="checkbox"/> | ISO 80 | |
| <input type="checkbox"/> | ISO 100 | |
| <input type="checkbox"/> | ISO 200 | |
| <input type="checkbox"/> | ISO 400 | |
| <input type="checkbox"/> | ISO 800 | |
| <input type="checkbox"/> | ISO 1600 | |
| <input type="checkbox"/> | ISO 3200 | |

- For details on the ISO sensitivity, see page 9.
- When  (Extra High Sensitivity) mode is set in the Scene Selection mode, sensitivity is increased up to a maximum of 6400.
- You can select only from [ISO AUTO], [ISO 400] or [ISO 800] when set to  (Extra High-speed Burst) mode in the scene selection.
- You can select only from [ISO AUTO], [ISO 80] to [ISO 400] when set to Burst or Exposure Bracket.
- When shooting under brighter conditions, the camera automatically increases its tone reproduction and helps prevent images to become whitish (excluding when [ISO] is set to [ISO 80]).

Metering Mode: Selecting the metering mode



Selects the metering mode that sets which part of the subject to measure to determine the exposure.

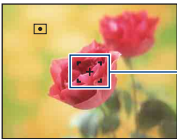



| | | |
|---|--------------------------------------------------------------------------------------------------------------------|------------------------------------------------------------------------------------------------------------------------------------------------------------------------------------------------------------------------------------------------------------------------------------------------------------------------------------------------------------------------------------------------------------------------------------------------------------------------------------------------------------------------------------------------------------------------------------------------|
| ✓ |  (Multi) | Divides into multiple regions and measures each region. The camera determines a well-balanced exposure (Multi-pattern metering). |
| |  (Center) | Measures the center of the image, and determines the exposure based on the brightness of the subject there (Center-weighted metering). |
| |  (Spot) (Only for still image) | Measures only a part of the subject (Spot metering). <ul style="list-style-type: none"> This function is useful when the subject is backlit or when there is strong contrast between the subject and the background. <div data-bbox="415 586 603 732" style="display: inline-block; vertical-align: middle;">  </div> <div data-bbox="635 645 883 695" style="display: inline-block; vertical-align: middle;"> Spot metering cross hairs Positions on the subject </div> |

- For details on the Exposure, see page 9.
- When using spot metering or center-weighted metering, setting [Focus] to [Center AF] is recommended to focus on the metering position (page 58).
- You can select the metering mode only when [Face Detection] is set to [Off].

Focus: Changing the focus method

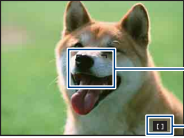

You can change the focus method. Use the menu when it is difficult to get the proper focus in auto focus mode.

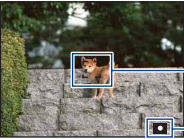
| | | |
|---|-----------------------------------------------------------------------------------------------|-----------------------------------------------------------------------------------------------------------------------------------------------------------------------------------------------------------------------------------------------------------------------------------------------------------------------------------------------------------------------------------------------------------------------------------------------------------------|
| ✓ |  (Multi AF) | <p>Focuses on a subject in all ranges of the finder frame automatically.</p> <ul style="list-style-type: none"> This mode is useful when the subject is not in the center of the frame.  <p>AF range finder frame (Only for still image)</p> <p>AF range finder frame indicator</p> |
| |  (Center AF) | <p>Focuses on a subject in the center of the finder frame automatically.</p> <ul style="list-style-type: none"> Using the AF lock function together, you can compose the image the way you want.  <p>AF range finder frame</p> <p>AF range finder frame indicator</p> |
| |  (Spot AF) | <p>Focuses on an extremely small subject or a narrow area automatically.</p> <ul style="list-style-type: none"> Using the AF lock function together, you can compose the image the way you want. Hold the camera steady so as not to misalign the subject and the AF range finder frame.  <p>AF range finder frame</p> <p>AF range finder frame indicator</p> |

| | |
|------------------------|-----------------------------------------------------------------------------------------------------------------------------------------------------------------------------------------------------------------------------------------------------------------------------------------------------------------------------------------------------------------------------------------------------------------------------------------------------------------------------|
| 0.5 m | Automatically focuses quickly on the area around a previously set distance (Semi manual). <ul style="list-style-type: none"> • Focuses on a subject in all ranges of the finder frame in semi manual mode. • This mode is useful when repeatedly shooting a subject at the same distance. • Use “Semi manual” when it is difficult to get sharp focus with automatic focusing, such as when shooting a subject through a net or window. |
| 1.0 m | |
| 3.0 m | |
| 7.0 m | |
| ∞ (unlimited distance) | |

- AF stands for Auto Focus.
- When you use Digital Zoom or AF illuminator, the AF range finder frame is disabled and appears in a dotted line. In this case, the camera works to focus on the subjects at the center of the screen.
- You can change the focus method only when [Face Detection] is set to [Off].
- You can select only [Multi AF] or [∞] when shooting movies.
- The semi manual distance setting contains some errors, and this error increases when the zoom is set to the T side or the lens is tilted upward or downward.

If the subject is out of focus

When shooting with the subject at the edge of the frame (or the screen), or when using [Center AF] or [Spot AF], the camera may not focus on a subject at the edge of the frame.

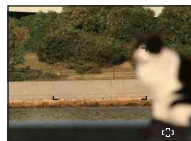

In such cases, do as follows:

- ① Recompose the shot so that the subject is centered in the AF range finder, and press the shutter button halfway down to focus on the subject (AF lock).

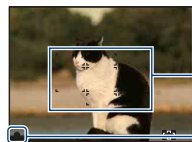

— AF range finder frame

— AE/AF lock indicator

As long as you do not press the shutter button fully down, you can retry the procedure as many times as you want.



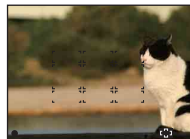

- ② When the AE/AF lock indicator stops flashing and remains on, return to the fully composed shot, and press the shutter button fully down.







White Balance: Adjusting the color tones



Adjusts color tones according to the surrounding light conditions. Use this function if image color appears unnatural.









| | | |
|---|---------------------------------------------------------------------------------|------------------------------------------------------------------------------------------------------------------------------------------------------------------------------------------------------------------------------------------------------------------------------------------------------|
| ✓ | WB AUTO (Auto) | Adjusts the White Balance automatically. |
| | ☀ (Daylight) | Adjusts for conditions outside under a clear sky, at sundown, night scenes, the presence of neon signs or fireworks.  |
| | ☁ (Cloudy) | Adjusts for a cloudy sky or a shady location.  |
| | 𠄎 (Fluorescent Light 1)/ 𠄎 (Fluorescent Light 2)/ 𠄎 (Fluorescent Light 3) | [Fluorescent Light 1]: Adjusts for white fluorescent lighting. [Fluorescent Light 2]: Adjusts for natural white fluorescent lighting. [Fluorescent Light 3]: Adjusts for day white fluorescent lighting.  |
| | 💡 (Incandescent) | Adjusts for places under an incandescent lamp, or under bright lighting, such as in a photo studio.  |

| | | |
|------------------------------------------------------------------------------------------------------|--|------------------------------------------------------------------------------------------------------------------------------------------------------------------------------------------------------------------|
|  WB (Flash) | | Adjusts for the flash conditions.  |
|  (One Push) | | Adjusts the white balance depending on the light source. The white color memorized in [One Push Set] mode becomes the basic white color. Use this mode when [Auto] or other modes cannot set the color properly. |
|  SET (One Push Set) | | Memorizes the basic white color which will be used in [One Push] mode. • This is unable to be selected while charging the flash. |

- For details on the white balance, see page 10.
- Under fluorescent lights that flicker, the white balance function may not work correctly even though you select [Fluorescent Light 1], [Fluorescent Light 2] or [Fluorescent Light 3].
- When shooting with a flash in other than [Flash] or [One Push] mode, [White Balance] is set to [Auto].
- When  (Underwater) mode is selected in the Scene Selection, you can use [Underwater White Balance] instead of [White Balance].
- You cannot select [Flash] when shooting movies.

To capture the basic white color in [One Push Set] mode





Memorizes the basic white color for the [One Push] mode. After selecting [One Push], do as follows.

- ① Frame a white object such as a piece of paper filling the screen under the same lighting conditions as you will shoot the subject.
 - ② Press the MENU button.
 - ③ Select [White Balance] with / on the control button, and [One Push Set] with /, then press .
 - ④ The screen momentarily turns black, and when the white balance has been adjusted and stored in the memory, the recording screen is displayed again.
- If the  indicator flashes while shooting, the white balance is either not set or cannot be set. Use automatic white balance.
 - Do not shake or strike the camera while [One Push Set] is in progress.
 - When flash mode is set to  (Flash forced on) or SL (Slow synchro), the white balance is adjusted to the condition with the flash emitting.
 - When [Color Filter] is set to other than [Off], white color cannot be memorized even if you shoot something white.

Underwater White Balance: Adjusting color tones during Underwater mode



Adjusts the color tone during  (Underwater) mode (page 31).



| | | |
|-------------------------------------|---------------------------------------------------------------------------------------------------------------|---------------------------------------------------------------------------------|
| <input checked="" type="checkbox"/> |  (Auto) | The camera automatically adjusts color tones underwater so they appear natural. |
| |  ₁ (Underwater 1) | Adjusts for underwater conditions where blue is strong. |
| |  ₂ (Underwater 2) | Adjusts for underwater conditions where green is strong. |
| |  (Flash) | Adjusts for use of flash underwater. |

- Depending on the color of the water, sometimes good adjustment is not possible regardless of whether [Underwater 1] or [Underwater 2] is selected.
- When shooting with a flash in other than [Flash] mode, [Underwater White Balance] is set to [Auto].

Flash Level: Adjusting the amount of flash light



Adjusts the amount of flash light.



| | | |
|-------------------------------------|-----------------------------------------------------------------------------------------------------------|-----------------------------------------|
| |  - (-) | Toward -: Makes the flash level lower. |
| <input checked="" type="checkbox"/> |  _{STD} (Normal) | |
| |  + (+) | Toward +: Makes the flash level higher. |

- To change flash mode, see page 26.
- If the subject is too bright or dark, this adjustment may have no effect.

Red Eye Reduction: Setting the Red Eye Reduction function



The flash strobes two or more times before shooting to reduce the red-eye phenomenon when using the flash.



| | | |
|---|------------------------------------------------------------------------------------------|------------------------------------------------------------------------------------------------------------------|
| ✓ |  (Auto) | When the Face Detection function is activated, the flash strobes automatically to reduce the red-eye phenomenon. |
| |  (On) | The flash always strobes to reduce the red-eye phenomenon. |
| |  (Off) | Does not use Red Eye Reduction. |

- To avoid blurring of images, hold the camera firmly until the shutter is released. It usually takes a second after you press the shutter button. Be also sure not to allow the subject to move during this period.
- Red-eye reduction may not produce the desired effects. It depends on individual differences and conditions, such as distance to the subject, or if the subject looked away from the pre-strobe. In such a case, you can correct the red-eye using [Retouch] in the viewing menu after shooting (page 72).
- When the Face Detection function is not used, the flash will not strobe to reduce red-eye phenomenon even when [Auto] is selected.

DRO: Optimizing the brightness and contrast



Analyzes the scene to be shot, and improves the image quality by automatic correction.

| | | |
|---|--------------------------------------------------------------------------------------------------|--------------------------------------------------------------------------------------|
| |  (Off) | Does not adjust. |
| ✓ |  (DRO standard) | The camera automatically adjusts the brightness and contrast of the entire scene. |
| |  (DRO plus) | The camera automatically adjusts brightness and contrast of the images area-by-area. |

- DRO is an abbreviation for “Dynamic Range Optimizer,” a function that automatically optimizes the difference between light and dark parts of an image.
- Depending on shooting conditions, it may not be possible to obtain correction effects.
- Note the following points when [DRO plus] is set.
 - Time is required for image processing.
 - You can select only from [ISO AUTO], [ISO 80] to [ISO 400].
 - When Burst/bracket shooting is selected, [DRO plus] is canceled and [DRO standard] is set.

Noise Reduction: Adjusting the Noise Reduction









Adjusts the clearness/noise balance of the recording images.





| | | |
|---|----------------------------------|-------------------------------------------------------------------------------------------|
| | NR- (-) | Toward-: Weakens noise reduction. This setting puts emphasis on clearness of images. |
| ✓ | NR_{STD} (Normal) | |
| | NR+ (+) | Toward+: Strengthens noise reduction. This setting puts emphasis on elimination of noise. |

Color Mode: Changing the vividness of the image or adding special effects



You can change the brightness of the image, accompanied by effects.

| | | |
|---|--------------------------------------------------------------------------------------------|--------------------------------------------------------------------------------------------------------------------------------|
| ✓ |  (Normal) | Sets the image to standard color.  |
| |  (Vivid) | Sets the image to bright and deep color.  |
| |  (Real) | Sets the image similar to real color.  |













| | | |
|--|-------------------------------------------------------------------------------------------|-------------------------------------------------------------------------------------------------------------------------|
| |  (Sepia) | Sets the image to sepia color.  |
| |  (B & W) | Sets the image to black and white.  |



- You can select only [Normal], [Sepia] or [B & W] when shooting movies.

Color Filter: Setting the Color Filter function



You can add color effects to images as if you use a color filter.

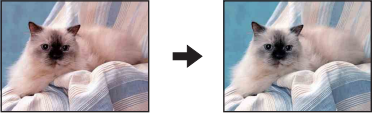

| | | |
|-------------------------------------|--------------------------------------------------------------------------------------------|---------------------------------------------------------------------------------------------------------------------------------------------------------------------------------------------------------------------------------------------------------------------------------------------------------------------------|
| <input checked="" type="checkbox"/> |  (Off) | Does not use the color filter. |
| |  (Red) | Makes red tones of sunset, etc., stand out.    |
| |  (Green) | Makes green tones of tender young leaves, etc., stand out.    |
| |  (Blue) | Makes blue tones of sky and sea, etc., stand out.    |

| | | |
|--|-----------------------------------------------------------------------------------------------|------------------------------------------------------------------------------------------------------------------------------------------------|
| |  Warm (Warm) | <p>Makes warmer tones for portraits and landscapes, etc.</p>  |
| |  Cool (Cool) | <p>Makes cooler tones for portraits and landscapes, etc.</p>  |

Color Saturation: Adjusting the Color Saturation





Adjusts the brightness (Color Saturation) of the shooting images.

| | | |
|---|------------------------------------------------------------------------------------------------|-----------------------------------|
| |  (-) | Toward -: Produces muted colors. |
| ✓ |  STD (Normal) | |
| |  (+) | Toward +: Produces bright colors. |

Contrast: Adjusting the Contrast





Adjusts the contrast of the image.

| | | |
|---|-------------------------------------------------------------------------------------------------|----------------------------------|
| |  (-) | Toward -: Reduces the contrast. |
| ✓ |  STD (Normal) | |
| |  (+) | Toward +: Enhances the contrast. |

Sharpness: Adjusting the Sharpness







Adjusts the sharpness of the image.

| | | |
|---|--------------------------------------------------------------------------------------------------|-------------------------------|
| |  (-) | Toward -: Softens the image. |
| ✓ |  STD (Normal) | |
| |  (+) | Toward +: Sharpens the image. |

SteadyShot: Selecting the anti-blur mode

Selects the anti-blur mode.

| | | |
|----------------------------------------------------------------------------------|------------------------------------------------------------------------------------------------|-------------------------------------------------------------------------------------------------------------------------------------------------------------------|
|  |  (Shooting) | Activates the anti-blur function when pressing the shutter button halfway down. |
| |  (Continuous) | Always activates the anti-blur function. You can stabilize images even when zooming up a far subject. • Battery consumption is faster than in [Shooting] mode. |
| |  (Off) | Does not use anti-blur mode. |

- In Auto Adjustment mode or Easy Shooting mode, [SteadyShot] is set to [Shooting].
- For movies, you can set [Continuous] or [Off] only.
The default setting is set to [Continuous].
- The anti-blur function may not work properly in the following cases.
 - When camera shake is too strong.
 - When the shutter speed is slow, for example, shooting night scenes.

 (Shooting Settings): Selecting the Shooting Settings

Selects the settings for the shooting function. The items appearing in this menu are the same ones as those in [ Shooting Settings] on the HOME screen. See pages 45, 89.



Selecting the View Mode

When using the camera with a “Memory Stick Duo”, you can select how images are played back (View Mode) from the HOME screen.

When using internal memory, images are displayed only in Folder View mode.

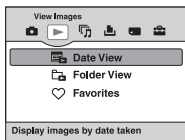

- 1 Press the HOME button to display the HOME screen.
- 2 Select (View Images) with / on the control button.
- 3 Select the desired View Mode with / , then press .

(Date View): Display by date

Separates the images stored on the “Memory Stick Duo” by the date and displays. The default setting is [Date View].

(Folder View): Display by folder

Displays images for each folder created using [Create REC.Folder] of the [Memory Tool]. If a new folder has not been created, all images are located in the “101MSDCF” folder. For details on the folder, see page 79, 82.

(Favorites): Displaying images registered as Favorites

This feature displays images registered as favorites (page 70).

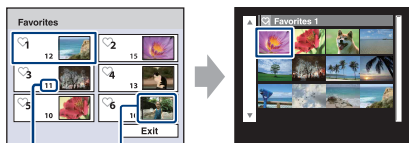

Number of images registered as Favorites

Display images having the most recently date

- 1 Select the Favorites group you want to play back with / / on the control button, then press .
- 2 Press after selecting the image you want to play back in single-image mode.

Viewing menu

This section explains the menu items available when you press the MENU button in playback mode. For details on how to use the menu, see page 46.



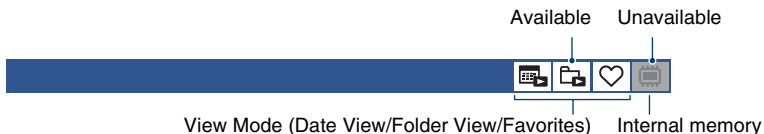

The selectable playback mode is displayed in white.



(Delete): Deleting images



Selects and deletes images on the single-image screen or the index screen, see page 42.

| | |
|-------------------------------------------------------------------------------------------------------------|---------------------------------------------------------------------------------------------------------------------------|
|  (This Image) | Deletes the image that is now selected. • This item appears only in single-image mode. |
|  (Multiple Images) | Selects and deletes multiple images. |
|  (All Images in Date Range) | Deletes all the images of the selected date/folder. • The displayed messages vary depending on the selected View Mode. |
|  (All In This Folder) | |

(View Mode): Switching the View Modes





Selects the View Mode. This item has same function as  (View Images) on the HOME screen.

See page 68.

(Date List): Selecting the playback date when using Date View



This feature selects the date to be played back when using Date View.

- Press the MENU button while displaying in single-image or index mode.
 - Select [Date List] with / on the control button, then press .
- A list of dates (calendar) is displayed.



- Select the date you want to display with ///, then press .

Q (Filter by Faces): Playing back images filtered to meet certain conditions

This feature filters images and displays them.

| | |
|--------------|---------------------------------------------------------------------------|
| (Off) | Images are not filtered. |
| (All people) | Images are filtered according to specified conditions and then displayed. |
| (Children) | |
| (Infants) | |
| (Smiles) | |

- Images may not be displayed correctly even if the images are filtered according to the specified conditions.
- Sometimes filtering cannot be performed with images shot using earlier Sony models.

♥ (Add / Remove Favorites): Adding/Removing Favorites

Select your favorite image and add/remove from groups as favorites.

| | |
|----------------------------|---------------------------------------------------------------------------------------------------------------------------------------------------------------------------------------|
| (This Image) | Add or remove the image you selected as favorites. <ul style="list-style-type: none"> • This item appears only in single-image mode. |
| (Multiple Images) | Select multiple images and add or remove them as favorites. |
| (Add All in Date Range) | Add all the images in the selected date range and add them as favorites. <ul style="list-style-type: none"> • This item appears only during list display in Date View. |
| (Remove All in Date Range) | Remove all images within the selected date/favorites list. <ul style="list-style-type: none"> • The displayed messages vary depending on the selected View Mode. |
| (Remove All in Favorites) | <ul style="list-style-type: none"> • This item appears only in index mode. |

To add an image to a Favorites group

- ① Select the image you want to add to a Favorites group while displaying images in single-image mode.
- ② Press the MENU button.
- ③ Select [Add / Remove Favorites] with ▲/▼ on the control button, and select [This Image] with ◀/▶, and then press ●.
- ④ Select the Favorites group you want to add the image to with ▲/▼/◀/▶, then press ●.
- ⑤ Press the MENU button.
- ⑥ Select [OK] with ▲, then press ●.

To select and add multiple images to a Favorites group

- ① Press the MENU button while displaying images in single-image mode or in index mode.
- ② Select [Add / Remove Favorites] with ▲/▼ on the control button, and select [Multiple Images] with ◀/▶, and then press ●.
- ③ Select the Favorites group you want to add the images to with ▲/▼/◀/▶, then press ●.

In single-image mode:

- ④ Display the image you want to add with ◀/▶, then press ●.
A ✓ is attached to the selected image.
- ⑤ Press ◀/▶ to display other images you want to add, then press ●.
- ⑥ Press the MENU button.
- ⑦ Select [OK] with ▲, then press ●.

In index mode:

- ④ Select the image you want to add with ▲/▼/◀/▶, then press ●.
A ✓ is attached to the selected image.
- ⑤ Repeat step ④ to add other images.
To select all the images of a specified date, select the bar with ◀, then press ●.
- ⑥ Press the MENU button.
- ⑦ Select [OK] with ▲, then press ●.

To add all the images of a specified date

- ① Press the MENU button while displaying images in index mode.
- ② Select [Add / Remove Favorites] with ▲/▼ on the control button.
- ③ Select [Add All in Date Range] with ◀/▶, and then press ●.
- ④ Select the Favorites group you want to add the images to with ▲/▼/◀/▶, then press ●.
- ⑤ Select [OK] with ▲, then press ●.

To remove from Favorites

Select the image you want to remove by performing the same procedure as in “To select and add multiple images to a Favorites group”.

The ♥ disappears.

- Select [Remove All in Date Range]/[Remove All in Favorites] to remove all the images of the selected date or Favorites group.

(Slideshow): Playing back a series of images





This item has the same function as pressing  (Slideshow) button.
See page 38.





 (Retouch): Retouching still images

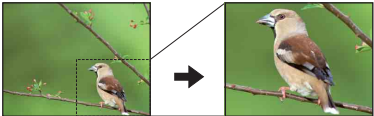

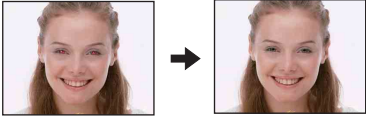

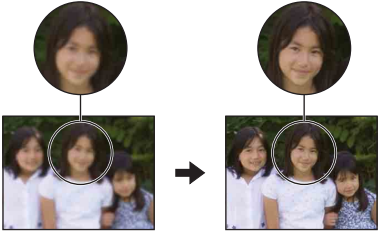

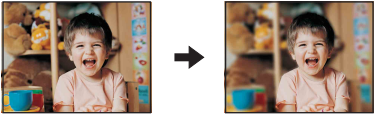
Adds effects or makes corrections to a recorded image and records it as a new file. The original image is retained.



To retouch the still images

- ① Select the images you want to retouch while displaying in single-image.
- ② Press the MENU button.
- ③ Select [Retouch] with ▲/▼ on the control button, then press ● after selecting the desired mode with ◀/▶.
- ④ Retouch the images following the instructions for each retouching mode below.

| | |
|--------------------------------------------------------------------------------------------------------|----------------------------------------------------------------------------------------------------------------------------------------------------------------------------------------------------------------------------------------------------------------------------------------------------------------------------------------------------------------------------------------------------------------------------------------------------------------------------------------------------------------------------------------------------------------------------------------------------------------------------------------------------------------------------------------------|
|  (Trimming) | <p>Playback zoom is performed on the image and part of the image is cropped.</p>  <ol style="list-style-type: none"> ① Press W/T to zoom in on the trimming range. ② Set the point with ▲/▼/◀/▶, then press the MENU button. ③ Select [Image Size] with ▲/▼, then press ●. Select an image size to record with ▲/▼, then press ● again. ④ Select [OK] with ▲/▼, then press ●. <ul style="list-style-type: none"> • The image size that you can trim may vary depending on the image. • The quality of trimmed images may deteriorate. |
|  (Red Eye Correction) | <p>Corrects the red-eye phenomenon caused by flash.</p>  <p>Select [OK] with ▲/▼, then press ●.</p> <ul style="list-style-type: none"> • You may not be able to correct the red-eye phenomenon depending on the image. |

| | |
|----------------------------------------------------------------------------------------------------|-----------------------------------------------------------------------------------------------------------------------------------------------------------------------------------------------------------------------------------------------------------------------------------------------------------------------------------------------------------------------------------------------------------------------------------------------------------------------------------------------------------------------------------|
|  (Unsharp masking) | <p>Sharpens the image within a chosen frame.</p>  <ol style="list-style-type: none"> ① Set the area (frame) of the desired image to retouch with ▲/▼/◀/▶, then press the MENU button. ② Select [OK] with ▲/▼, then press ●. <ul style="list-style-type: none"> • Depending on the image, correction may not be sufficient, or quality of the image may be reduced. |
|  (Soft Focus) | <p>Blurs the periphery around a chosen point to emphasize a subject.</p>  <ol style="list-style-type: none"> ① Set the center point of the desired image to retouch with ▲/▼/◀/▶, then press the MENU button. ② Select [Level] with ▲/▼, then press ●. Select level of retouch with ▲/▼, then press ● again. ③ Adjust the desired range to retouch with W/T. ④ Select [OK] with ▲/▼, then press ●. |
|  (Partial Color) | <p>Surrounds a chosen point in monochrome to signalize a subject.</p>  <ol style="list-style-type: none"> ① Set the center point of the desired image to retouch with ▲/▼/◀/▶, then press the MENU button. ② Adjust the desired range to retouch with W/T. ③ Select [OK] with ▲/▼, then press ●. |

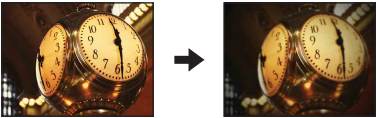

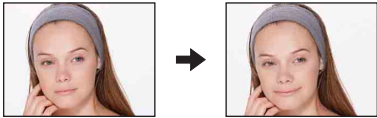

| | |
|--------------------------------------------------------------------------------------------------|----------------------------------------------------------------------------------------------------------------------------------------------------------------------------------------------------------------------------------------------------------------------------------------------------------------------------------------------------------------------------------------------------------------------------------------------------|
|  (Fisheye Lens) | <p>Applies a fisheye effect around a chosen point.</p>  <ol style="list-style-type: none"> ① Set the center point of the desired image to retouch with ▲/▼/◀/▶, then press the MENU button. ② Select [Level] with ▲/▼, then press ●. Select level of retouch with ▲/▼, then press ● again. ③ Select [OK] with ▲/▼, then press ●. |
|  (Cross Filter) | <p>Adds starburst effects to light sources.</p>  <ol style="list-style-type: none"> ① Select [Level] with ▲/▼, then press ●. Select level of retouch with ▲/▼, then press ● again. ② Adjust the desired length to retouch with W/T. ③ Select [OK] with ▲/▼, then press ●. |
|  (Radial Blur) | <p>Decides the center point for expressing movement in the still image.</p>  <ol style="list-style-type: none"> ① Set the center point of the desired image to retouch with ▲/▼/◀/▶, then press the MENU button. ② Adjust the desired range to retouch with W/T. ③ Select [OK] with ▲/▼, then press ●. |

| | |
|------------------------------------------------------------------------------------------------|----------------------------------------------------------------------------------------------------------------------------------------------------------------------------------------------------------------------------------------------------------------------------------------------------------------------------------------------------------------------------------------------------------------------------------------------------------------------------------------------------------------------------------------------|
|  (Retro) | <p>This softens the image by blurring the focus and lowering the surrounding light so that it appears as if it was taken by an old camera.</p>  <ol style="list-style-type: none"> ① Select [Level] with ▲/▼, then press ●. Select level of retouch with ▲/▼, then press ● again. ② Adjust the desired range to retouch with W/T. ③ Select [OK] with ▲/▼, then press ●. |
|  (Happy Faces) | <p>This feature puts a smile on a person's face. When the camera detects a face that can be retouched, a frame appears around the face.</p>  <ol style="list-style-type: none"> ① Select [Level] with ▲/▼, then press ●. Select level of retouch with ▲/▼, then press ● again. ② Select [OK] with ▲/▼, then press ●. <ul style="list-style-type: none"> • Retouching may not be possible depending on the image. |

 (Multi-Purpose Resize): Changing the image size according to usage

You can change the aspect ratio and size of the shooting images, then record them as the new files.

You can convert images to the 16:9 aspect ratio for high definition viewing and to the VGA size for blog or e-mail attachments.



| | |
|---------------------------------------------------------------------------------------------------|-----------------------------------------------------------------------------------------------------------------------------------------------------------|
| HDTV () | Changes the aspect ratio from 4:3/3:2 to 16:9 and saves as 2M size.  |
| Blog/E-mail () | Changes the aspect ratio from 16:9/3:2 to 4:3 and saves as VGA size.  |

- ① Select the images you want to retouch while displaying in single-image.
- ② Press the MENU button.
- ③ Select the [Multi-Purpose Resize] with ▲/▼ on the control button, then press ● after selecting the desired size of the image with ◀/▶.
- ④ Press W/T to zoom in from the area you want to trim.
- ⑤ Set the point with ▲/▼/◀/▶, then press the MENU button.
- ⑥ Select [OK] with ▲, then press ●.



- For details about the image size, see page 11.
- You cannot resize movies.
- You cannot resize the images from VGA to [HDTV].
- Enlarging the image and multi resizing can reduce the image quality.

 (Protect): Preventing accidental erasure



Protects images against accidental erasure. The  (Protect) indicator appears on a protected image.

| | |
|----------------------------------------------------------------------------------------------------|--------------------------------------------------------------------------------------------------|
|  (This Image) | Protects/unlocks the currently selected image. • This item appears only in single-image mode. |
|  (Multiple Images) | Selects and protects/unlocks multiple images. |







To protect an image

- ① Select the images you want to protect while displaying images in single-image mode.
- ② Press the MENU button.
- ③ Select [Protect] with  on the control button, [This Image] with , and then press .









**To select and protect images**

- ① Press the MENU button while displaying images in single-image mode or in index mode.
- ② Select [Protect] with , and select [Multiple Images] with , then press .

In single-image mode:

- ③ Select the image you want to protect with , then press .
The  is attached to the selected image.
- ④ Press  to display other images you want to protect, then press .
- ⑤ Press the MENU button.
- ⑥ Select [OK] with , then press .

In index mode:

- ③ Select the image you want to protect with /, then press .
The  is attached to the selected image.
 - ④ To protect other images, repeat step ③.
To select all the images of a date/folder/favorites, select the bar with , then press .
 - ⑤ Press the MENU button.
 - ⑥ Select [OK] with , then press .
- Note that the formatting erases all the data stored on the recording media, even if the images are protected, and these images cannot be restored.
 - It may take some time to protect an image.

To cancel the protection



Select the image for which you want to cancel protection, and unlock it by taking the same steps as in “To select and protect images”.

The  (Protect) indicator disappears.

DPOF: Adding a Print order mark



Adds a print order mark (DPOF) to the image you want to print.
See page 118.

| | |
|----------------------------------------------------------------------------------------------------------|---------------------------------------------------------------------------------------------------------------------|
| DPOF  (This Image) | Attaches a DPOF mark to the currently selected image. Clears the DPOF mark when the selected image has a DPOF mark. |
| DPOF  (Multiple Images) | Selects images and attaches DPOF marks to them. Clears DPOF marks already attached. |

(Print): Printing images using a printer













Printing images shot with the camera.
See page 115.

(Rotate): Rotating a still image





Rotates a still image.

- ① Display the image to be rotated.
- ② Press the MENU button to display the menu.
- ③ Select [Rotate] with / on the control button, then press .
- ④ Select [ ], then rotate the image with /.
- ⑤ Select [OK] with /, then press .



- You cannot rotate protected images or movies.
- You may not be able to rotate images shot with other cameras.
- When viewing images on a computer, the image rotation information may not be reflected depending on the software.

 (Select Folder): Selecting the folder for viewing images

Selects the folder containing the image you want to play back.

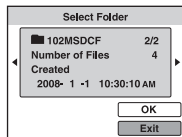
- ① Select the desired folder with /  on the control button.



- ② Select [OK] with , then press .

To cancel selecting the folder

Select [Exit] in step ②, then press .

 On the folders

The camera stores images in a specified folder of a “Memory Stick Duo”. You can change the folder or create a new one.

- To create a new folder → [Create REC.Folder] (page 82)
- To change the folder for recording images → [Change REC.Folder] (page 83)
- When multiple folders are created in the “Memory Stick Duo” and the first or last image in the folder is displayed, the following indicators appear.

: Moves to the previous folder

: Moves to the next folder



: Moves to either the previous or next folders

Customizing the Manage Memory feature and the Settings

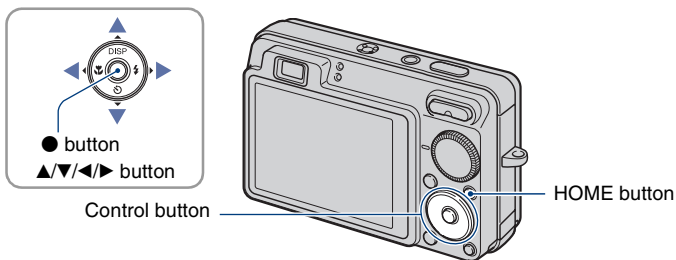
You can change the default settings using  (Manage Memory) or  (Settings) on the HOME screen.



1 Press the HOME button to display the HOME screen.

2 Select  (Manage Memory) or  (Settings) with /▶ on the control button.

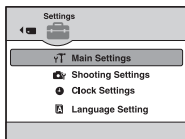

3 Select an item with /▼, then press .

4 Select the desired setting with /▼, then press .

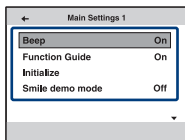

- The HOME screen is displayed by pressing .

5 Select a setting with ▲/▼, then press ●.

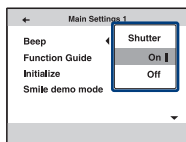

To cancel the setting change

Select [Cancel] if it is shown as an option on the screen, then press ●.

If not, press ◀.

- This setting is maintained even when the power is turned off.
- The camera is set to the shooting or viewing mode by pressing the HOME button again.

Memory Tool — Memory Stick Tool

This item appears only when a “Memory Stick Duo” is inserted in the camera.

Format

Formats the “Memory Stick Duo”. A commercially available “Memory Stick Duo” is already formatted, and can be used immediately.

• Note that formatting permanently erases all data on a “Memory Stick Duo”, including even protected images.

- ① Select [Format] with ▲/▼ on the control button, then press ●.
The message “All data on Memory Stick will be erased” appears.
- ② Select [OK] with ▲, then press ●.
Formatting starts.

To cancel formatting

Select [Cancel] in step ②, then press ●.

Create REC.Folder

Creates a folder in a “Memory Stick Duo” for recording images.

- ① Select [Create REC.Folder] with ▲/▼ on the control button, then press ●.
The folder creation screen appears.



- ② Select [OK] with ▲, then press ●.
A new folder is created with a number incremented one higher than the largest number, and the folder becomes the current recording folder.

To cancel the folder creation

Select [Cancel] in step ②, then press ●.

- When not creating a new folder, the “101MSDCF” folder is selected as the recording folder.
- You can create folders designated up to “999MSDCF”.
- You cannot delete a folder with the camera. To delete a folder, use your computer, etc.
- Images are recorded in the newly created folder until you create another folder or select another recording folder.
- Up to 4,000 images can be stored in one folder. When the folder capacity is exceeded, a new folder is automatically created.
- For details, see “Image file storage destinations and file names” (page 105).

Change REC.Folder

Changes the folder currently used for recording images.

- ① Select [Change REC.Folder] with ▲/▼ on the control button, then press ●.
The folder selection screen appears.

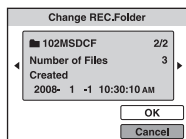

- ② Select the desired folder with ◀/▶, and [OK] with ▲, then press ●.

To cancel changing the recording folder

Select [Cancel] in step ②, then press ●.

- You cannot select the “100MSDCF” folder as a recording folder.
- You cannot move recorded images to another folder.

Copy

Copies all images in the internal memory to a “Memory Stick Duo”.

- ① Insert a “Memory Stick Duo” having sufficient free capacity.
- ② Select [Copy] with ▲/▼ on the control button, then press ●.
The message “All data on internal memory will be copied” appears.
- ③ Select [OK] with ▲, then press ●.
Copying starts.

To cancel copying

Select [Cancel] in step ③, then press ●.

- Use a fully charged battery pack. If you attempt to copy image files using a battery pack with little remaining charge, the battery pack may run out, causing copying to fail or possibly corrupting the data.
- You cannot select images to copy.
- The original images in the internal memory are retained even after copying. To delete the contents of the internal memory, remove the “Memory Stick Duo” after copying, then format the internal memory ([Format] in [Internal Memory Tool]) (page 84).
- A new folder is created on the “Memory Stick Duo” and all the data will be copied to it. You cannot choose a specific folder and copy images to it.
- The **DPOF** (Print order) marks on the images are not copied.



Memory Tool — Internal Memory Tool

This item does not appear when a “Memory Stick Duo” is inserted in the camera.

Format

Formats the internal memory.

- Note that formatting permanently erases all data in the internal memory, including even protected images.

- ① Select [Format] with ▲/▼ on the control button, then press ●.
The message “All data on internal memory will be erased” appears.
- ② Select [OK] with ▲, then press ●.
Formatting starts.

To cancel formatting

Select [Cancel] in step ②, then press ●.

Main Settings — Main Settings 1

The default settings are marked with .

Beep

Selects the sound produced when you operate the camera.

| | | |
|----------------------------------------------------------------------------------|---------|----------------------------------------------------------------------------|
| | Shutter | Turns on the shutter sound when you press the shutter button. |
|  | On | Turns on the beep/shutter sound when you press the control/shutter button. |
| | Off | Turns off the beep/shutter sound. |





Function Guide

When you operate the camera, the function guide appears.

| | | |
|----------------------------------------------------------------------------------|-----|--------------------------------------|
|  | On | Displays the function guide. |
| | Off | Does not display the function guide. |

Initialize

Initializes the setting to the default setting. Even if you execute this function, the images stored in the internal memory are retained.

- ① Select [Initialize] with / on the control button, then press .
- The message “Reset to default settings” appears.
- ② Select [OK] with , then press .
- The settings are reset to the default setting.

To cancel initializing

Select [Cancel] in step ②, then press .

- Be sure not to power off the camera while initializing.

Smile demo mode

You can view a demonstration of the Smile Shutter mode.

| | | |
|---|-----|---------------------------------------------------------|
| | On | Executes a demonstration when using Smile Shutter mode. |
| ✓ | Off | Does not execute. |

- ① Select 😊 (Smile Shutter) mode from the mode dial (page 29).
 - ② Aim the camera at the subject and press the shutter button all the way down.
The demonstration starts.
- If you do not operate the camera for about 15 seconds, the demonstration starts automatically even if the shutter button is not pressed.
 - You can temporarily exit the demonstration after it starts by pressing the shutter button all the way down.
 - Although the shutter is released when the camera detects a smile, no image is recorded.
 - Always set to [Off] to take an actual Smile Shutter shot.

Main Settings — Main Settings 2

The default settings are marked with .

USB Connect

Selects the USB mode when connecting the camera to a computer or a PictBridge compliant printer using the cable for multi-use terminal.

| | | |
|----------------------------------------------------------------------------------|--------------|--------------------------------------------------------------------------------------------------------------------------------------------------------------------------------------------------------------------------------------------------------------------------------------------------------------------------------------------------------------------------------------------------------------------------------|
|  | Auto | The camera recognizes automatically and sets up communication with a computer or PictBridge compliant printer (pages 103, 115). <ul style="list-style-type: none"> • If you cannot connect the camera to a PictBridge compliant printer with the [Auto] setting, select [PictBridge]. • If you cannot connect the camera to a computer or a USB device with the [Auto] setting, select [Mass Storage]. |
| | PictBridge | Connects the camera to a PictBridge compliant printer (page 115). |
| | PTP/MTP | When you connect the camera to a computer, the copy wizard starts automatically, and the images in the recording folder on the camera are copied to the computer. (with Windows Vista/XP, Mac OS X) |
| | Mass Storage | Establishes a Mass Storage connection between the camera and a computer or other USB device (page 103). |

COMPONENT

Selects the video signal output type from SD and HD(1080i), according to the TV connected (page 95).

| | | |
|------------------------------------------------------------------------------------|-----------|-------------------------------------------------------------------------------------------------|
|  | HD(1080i) | Select this item to connect the camera to a 1080i-capable High Definition TV. |
| | SD | Select this item to connect the camera to a TV that is not compatible with an HD(1080i) signal. |

Video Out

Sets the video signal output according to the TV color system of the connected video equipment. The TV color systems differ depending on the country and region. To view images on a TV screen, check the TV color system of the country or region of use (page 97).

| | |
|------|-----------------------------------------------------------------------|
| NTSC | Sets the video output signal to NTSC mode (e.g., for the USA, Japan). |
| PAL | Sets the video output signal to PAL mode (e.g., for Europe). |

Wide Zoom Display

During playback on High Definition TV, still images at a 4:3 and 3:2 aspect ratio are played at a 16:9 aspect ratio. Images are displayed with the upper and lower sides slightly cut off.

| | | |
|-------------------------------------|-----|--------------------------------------------------------------------------------------------------------------------|
| <input type="checkbox"/> | On | Plays at a 16:9 aspect ratio.  |
| <input checked="" type="checkbox"/> | Off | Does not use Wide Zoom Display. |

- The only images that can be played in Wide Zoom are 4:3 and 3:2 images. Movies, 16:9 images, and portrait images cannot be zoomed.
- The image displayed on the LCD screen of the camera does not change.



Shooting Settings — Shooting Settings 1

The default settings are marked with .

AF Illuminator



The AF illuminator supplies fill light to focus more easily on a subject in dark surroundings. The AF illuminator emits red light allowing the camera to focus easily when the shutter button is pressed halfway, until the focus is locked. The  indicator appears at this time.

| | | |
|----------------------------------------------------------------------------------|------|------------------------------|
|  | Auto | Uses the AF illuminator. |
| | Off | Does not use AF illuminator. |

- If the AF illuminator light does not reach the subject sufficiently or the subject has no contrast, focus will not be achieved. (A distance of up to approximately 3.0 m (9 feet 10 1/8 inches) (zoom: W)/2.0 m (6 feet 6 3/4 inches) (zoom: T) is recommended.)
- Focus is achieved as long as the AF illuminator light reaches the subject, regardless of whether light fails to reach the center of the subject.
- You cannot use the AF illuminator when:
 - Semi manual is set (page 59).
 -  (Landscape) mode,  (Twilight) mode or  (Fireworks) mode is selected in the Scene Selection mode.
 - Shooting movies
- When you use AF illuminator, the normal AF range finder frame is disabled and new AF range finder frame is displayed by a dotted line. AF operates with priority on subjects located near the center of the frame.
- The AF illuminator emits very bright light. Although there is no health hazard, do not look directly into the AF illuminator emitter at close range.

Grid Line

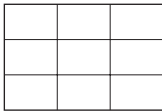
With reference to the grid lines, you can easily set a subject in a horizontal/vertical position.

| | | |
|------------------------------------------------------------------------------------|-----|-----------------------------------------------------------------------------------------------------------------|
| | On | Displays the grid lines.  |
|  | Off | Does not display the grid lines. |

- The grid lines are not recorded.

AF Mode

Selects the auto focus operation mode.

| | | |
|-------------------------------------|---------|------------------------------------------------------------------------------------------------------------------------------------------------------------------------------------------------------------------------------------------------------|
| <input checked="" type="checkbox"/> | Single | Automatically adjusts the focus when you press and hold the shutter button halfway down. This mode is useful for shooting stationary subjects. |
| <input type="checkbox"/> | Monitor | Automatically adjusts the focus before you press and hold the shutter button halfway down. This mode shortens the time needed for focusing. <ul style="list-style-type: none"> • Battery consumption is faster than in [Single] mode. |

- AF mode setting is invalid when  (Fireworks) mode is selected in the Scene Selection mode.
- When the Face Detection or Smile Detection function is activated, the AF mode functions as if [Monitor] is selected.
- When using semi manual, the AF mode functions as if [Single] is selected.



Digital Zoom

Selects the digital zoom mode. The camera enlarges the image using optical zoom (up to 3×). When the zoom scale exceeds 3×, the camera uses either smart or precision digital zoom.

| | | |
|-------------------------------------|-----------------------------------------------|-----------------------------------------------------------------------------------------------------------------------------------------------------------------------------------------------------------------------------------------------------------------------------------------------------------------------------------|
| <input checked="" type="checkbox"/> | Smart (Smart zoom) (sQ) | Enlarges the image digitally within the range where the image will not be distorted, according to the image size. This is not available when the image size is set to [13M], [3:2 (12M)] or [16:9 (10M)]. <ul style="list-style-type: none"> • The total zoom scale of Smart zoom is shown in the following table. |
| <input type="checkbox"/> | Precision (Precision digital zoom) (PQ) | Enlarges all image sizes by the total zoom scale of approximately 6×, including the optical zoom 3×. However, note that the picture quality deteriorates when the optical zoom scale is exceeded. |
| <input type="checkbox"/> | Off | Does not use the digital zoom. |



Image size and total zoom scale using Smart zoom (Including optical zoom 3×)





| Size | Total zoom scale |
|-----------|------------------|
| 8M | Approx. 3.9 × |
| 5M | Approx. 4.9 × |
| 3M | Approx. 6.2 × |
| VGA | Approx. 19 × |
| 16:9 (2M) | Approx. 6.6 × |

- When  (Extra High Sensitivity) mode or  (Extra High-speed Burst) mode is selected in the Scene Selection mode, the Smart zoom does not function.
- You cannot use the Digital zoom when:
 -  (Smile Shutter) mode is selected in the Scene Selection mode.
 - The LCD screen is off.
 - Shooting movies

Conversion Lens

Sets for achieving appropriate focus when attaching a conversion lens (not supplied). Attach a lens adaptor (not supplied), then attach a conversion lens.

| | | |
|-------------------------------------|--------------------------------------------------------------------------------------------|----------------------------------|
| <input type="checkbox"/> | Tele () | Attaches a tele conversion lens. |
| <input type="checkbox"/> | Wide () | Attaches a wide conversion lens. |
| <input checked="" type="checkbox"/> | Off | Does not attach a lens. |

- When using the built-in flash, the flash light may be blocked, causing the shadow to appear.
- Check the image composition on the LCD screen when shooting.
- Macro is fixed to  AUTO (Auto).
- The available zoom area is limited.
- The available focusing area is limited.
- AF illuminator does not emit light.
- You cannot select semi manual.
- If you shoot images with a Tele conversion lens (not supplied), the camera may also focus on close subjects in  (Landscape) mode and  (Twilight) mode.
- If you shoot images with a conversion lens (not supplied), you may not be able to record images in  (Fireworks) mode with its optimal effect.
- Refer also to the operating instructions supplied with your conversion lens.

Shooting Settings — Shooting Settings 2

The default settings are marked with .

Auto Orientation

When the camera is rotated to shoot a portrait (vertical) image, the camera records its position change and displays the image in the portrait position.

| | | |
|----------------------------------------------------------------------------------|-----|-------------------------------------------------|
|  | On | Records the image with the correct orientation. |
| | Off | Does not use Auto Orientation. |

- Black is displayed to the left and right of vertical orientation images.
- Depending on the shooting angle of the camera, the orientation of the image may not be recorded correctly. If an image is not recorded in the correct orientation, you can rotate the image, following the procedure on page 78.
- When  (Underwater) mode is selected in the Scene Selection mode, you cannot use [Auto Orientation].

Auto Review

Displays the recorded image on the screen for approximately two seconds immediately after shooting a still image.

| | | |
|----------------------------------------------------------------------------------|-----|---------------------------|
|  | On | Uses the Auto Review. |
| | Off | Does not use Auto Review. |

- If you press the shutter button halfway down, the recorded image display disappears and you can immediately shoot the next image.
- You cannot use Auto Review when:
 -  (Extra High Sensitivity) mode is selected in the Scene Selection mode.
 - During burst/bracket shooting
 - When [Auto] or [Advanced] is selected in [Scene Recognition].









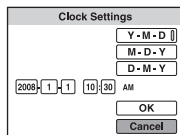

Clock Settings

Clock Settings

Sets the date and time.



- 1 Select [ Clock Settings] from  (Settings) on the HOME screen.



- 2 Press  on the control button.
- 3 Select the date display format with /, then press .
- 4 Select each item with / and set the numeric value with /, then press .
- 5 Select [OK], then press .

• Midnight is indicated as 12:00 AM, and noon as 12:00 PM.

To cancel the clock setting

Select [Cancel] in step , then press .

A Language Setting

Language Setting

Selects the language to be used in the menu items, warnings and messages.



Viewing images on a TV

You can view images on a TV by connecting the camera to a TV.
The connection varies according to the type of TV the camera is connected to.

Viewing images by connecting the camera to a TV with the supplied cable for multi-use terminal

Turn off both the camera and the TV before connecting the camera to the TV.

1 Connect the camera to the TV with the cable for multi-use terminal (supplied).

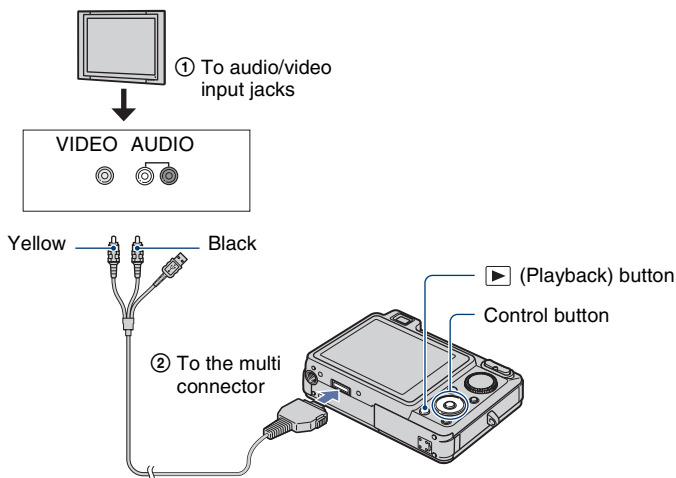

- If your TV has stereo input jacks, connect the audio plug (black) of the cable for multi-use terminal to the left audio jack.

2 Turn on the TV and set the input.

- Refer also to the operating instructions supplied with the TV.

3 Press (Playback) button to turn on the camera.

Images shot with the camera appear on the TV.

Press  on the control button to select the desired image.

- When using the camera abroad, it may be necessary to switch the video signal output to match that of your TV system (page 88).

Viewing an image by connecting the camera to an HDTV

You can view an image with high quality* recorded on the camera by connecting the camera to an HD (High Definition) TV with an HD Output Adaptor Cable (not supplied).

Turn off both the camera and the TV before connecting the camera to the TV.

* Images shot in [VGA] image size cannot be played back in HD format.

- In [Wide Zoom Display], still images with an aspect of 4:3 or 3:2 can be displayed with an aspect of 16:9 (page 88).
- In [Multi-Purpose Resize], the aspect can be converted to 16:9 for high definition viewing (page 76).

1 Connect the camera to an HD (High Definition) TV with the HD Output Adaptor Cable (not supplied).

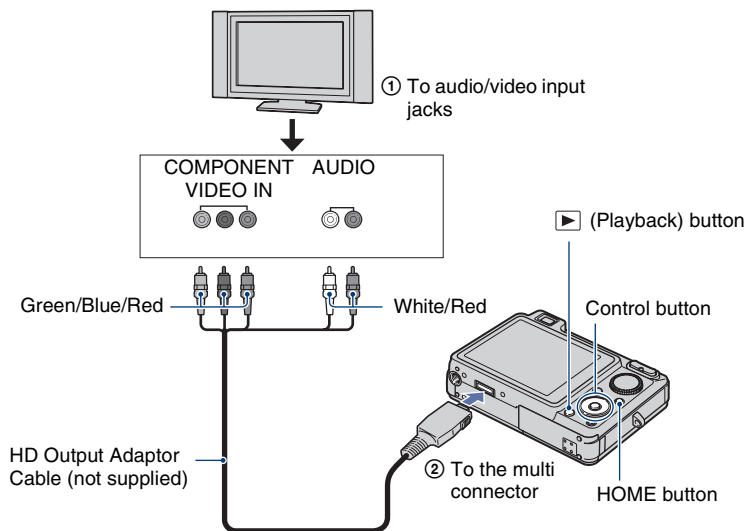

2 Turn on the TV and set the input.

- Refer also to the operating instructions supplied with the TV.

3 Press the (Playback) button to turn on the camera.

Images shot with the camera appear on the TV.

Press /▶ on the control button to select the desired image.

- Set [COMPONENT] to [HD(1080i)] in [Main Settings 2] by selecting  (Settings) on the HOME screen (page 87).
- When using the camera abroad, it may be necessary to switch the video signal output to match that of your TV system (page 88).
- You cannot view movies output in [HD(1080i)] signal format. Set [COMPONENT] to [SD] when viewing movies (page 87).

On “PhotoTV HD”

This camera is compatible with the “PhotoTV HD” standard.

By connecting Sony’s PhotoTV HD-compatible devices using an HD output adaptor cable (not supplied), whole new world of photos can be comfortably enjoyed in breathtaking Full HD quality.

PhotoTV HD allows for a highly-detailed, photo-like expression of subtle textures and colors.

- The settings are also required to be made on the TV. For details, refer to the operating instruction of the TV.

On TV color systems

If you want to view images on a TV screen, you need a TV with a video input jack and the cable for multi-use terminal. The color system of the TV must match that of the digital still camera. Check the following lists for the TV color system of the country or region where the camera is used.

NTSC system

Bahama Islands, Bolivia, Canada, Central America, Chile, Colombia, Ecuador, Jamaica, Japan, Korea, Mexico, Peru, Surinam, Taiwan, the Philippines, the U.S.A., Venezuela, etc.

PAL system

Australia, Austria, Belgium, China, Czech Republic, Denmark, Finland, Germany, Holland, Hong Kong, Hungary, Italy, Kuwait, Malaysia, New Zealand, Norway, Poland, Portugal, Singapore, Slovak Republic, Spain, Sweden, Switzerland, Thailand, United Kingdom, etc.

PAL-M system

Brazil

PAL-N system

Argentina, Paraguay, Uruguay

SECAM system

Bulgaria, France, Guiana, Iran, Iraq, Monaco, Russia, Ukraine, etc.



For details on using a Macintosh computer, refer to “Using your Macintosh computer” (page 111). Illustrations of screens used in this section are based on the English version.



Install the software (supplied) first (page 100)



- Installing the software as follows:
 - “Picture Motion Browser”
 - “Music Transfer”

Copying images to your computer (page 103)



- Copying images to your computer using “Picture Motion Browser”.
- Enjoying images using “Picture Motion Browser” and “Music Transfer” as follows:
 - Viewing images saved on your computer
 - Editing images
 - Displaying the shooting locations of still images on maps online
 - Creating a disc with the images shot (requires CD or DVD disc writing drive)
 - Printing or saving still images with the date
 - Adding/changing Music for slideshow (using “Music Transfer”)

Additional information on this product and answers to frequently asked questions can be found at the Sony Customer Support Website.
<http://www.sony.net/>

Recommended computer environment

The following environment is recommended for a computer connected to the camera.

Recommended environment for copying images

OS (pre-installed): Microsoft Windows 2000 Professional SP4, Windows XP* SP2, Windows Vista*

- Operation is not assured in an environment based on an upgrade of the operating systems described above or in a multi-boot environment.

USB jack: Provided as standard

Recommended environment for using “Picture Motion Browser” and “Music Transfer”

OS (pre-installed): Microsoft Windows 2000 Professional SP4, Windows XP* SP2, Windows Vista*

CPU: Intel Pentium III 500 MHz or faster (Recommended: Intel Pentium III 800 MHz or faster)

Memory: 256 MB or more (Recommended: 512 MB or more)

Hard Disk: Disk space required for installation— approximately 400 MB

Display: Screen resolution: 1,024 × 768 dots or more

* 64-bit editions and Starter (Edition) are not supported.

Notes on connecting the camera to a computer

- The computer environment must also satisfy the operating requirements of the OS.
- Operations are not guaranteed for all the recommended computer environments mentioned above.
- If you connect two or more USB devices to a single computer at the same time, some devices, including the camera, may not operate, depending on the types of USB devices you are using.
- Operations are not guaranteed when using a USB hub.
- Connecting the camera using a USB interface that is compatible with Hi-Speed USB (USB 2.0 compliant) allows advanced transfer (high speed transfer) as the camera is compatible with Hi-Speed USB (USB 2.0 compliant).
- There are four modes for a USB connection when connecting a computer, [Auto] (default setting), [Mass Storage], [PictBridge] and [PTP/MTP] modes. This section describes the [Auto] and [Mass Storage] as examples. For details on [PictBridge] and [PTP/MTP], see page 87.
- When your computer resumes from a suspend or sleep mode, communication between the camera and your computer may not recover at the same time.

Installing the software (supplied)

You can install the software (supplied) using the following procedure.

- Log on as Administrator.

1 Turn on your computer, and insert the CD-ROM (supplied) into the CD-ROM drive.

The installation menu screen appears.



- If it does not appear, double-click [Computer] (in Windows XP/2000, [My Computer]) →  (SONYPICUTIL).
- The AutoPlay screen may appear. Select “Run Install.exe.” and follow the instructions that appear on the screen to proceed with the installation.

2 Click [Install].

The “Choose Setup Language” screen appears.

3 Select the desired language, then click [Next].

4 The “License Agreement” screen appears.

Read the agreement carefully. If you accept the terms of the agreement, click the radio button next to [I accept the terms of the license agreement] and then click [Next].

5 Follow the instructions on the screen to complete the installation.



- When the restarting confirmation message appears, restart the computer following the instructions on the screen.
- DirectX may be installed depending on the system environment of your computer.

6 Remove the CD-ROM after the installation is complete.

- Installing software as follows:
 - Picture Motion Browser
 - Music Transfer

Installing the software (supplied)

After you install the software, the short cut icons for “Picture Motion Browser”, “PMB Guide”, “Music Transfer” are created on the desktop.

| | |
|-------------------------------------------------------------------------------------------------------------------------|-------------------------------------------------|
|  PMB - Picture Motion Browser | Double-click to start “Picture Motion Browser”. |
|  PMB Guide | Double-click to start “PMB Guide”. |
|  Picture Packae... | Double-click to start “Music Transfer”. |

On the “Picture Motion Browser” (supplied)

You can use still images and movies from the camera more than ever by taking advantage of the software.

This section summarizes the “Picture Motion Browser”.

“Picture Motion Browser” overview

With the “Picture Motion Browser” you can:

- Import images shot with the camera and display them on the computer.
- Organize images on the computer on a calendar by shooting date to view them.
- You can view image files stored on a computer with the camera by copying them to a “Memory Stick Duo”.
- Retouch (Red Eye Correction, etc.), print, and send still images as e-mail attachments, change the shooting date and more.
- Print or save the still images with the date.
- Create a data disc using a CD burner drive or DVD burner drive.
- Upload the image to the Web.
- For details, refer to “PMB Guide”.

Starting the “PMB Guide”

Double-click the  (PMB Guide) icon on the desktop.

To access “PMB Guide” from the Start menu, click [Start] → [All Programs] (in Windows 2000, [Programs]) → [Sony Picture Utility] → [Help] → [PMB Guide].

Starting and exiting the “Picture Motion Browser”

Starting the “Picture Motion Browser”

Double-click the  (Picture Motion Browser) icon on the desktop.

Or, from the Start menu: Click [Start] → [All Programs] (in Windows 2000, [Programs]) → [Sony Picture Utility] → [PMB - Picture Motion Browser].

- The confirmation message of the Information tool appears on the screen when starting the “Picture Motion Browser” for the first time. Select [Start]. This function informs you of news, such as software updates. You can change the setting later.

Exiting the “Picture Motion Browser”

Click  button on the top right corner of the screen.

Copying images to your computer using the “Picture Motion Browser”

Preparing the camera and the computer

1 Insert a “Memory Stick Duo” with recorded images into the camera.

- When copying images in the internal memory, this step is unnecessary.

2 Insert the sufficiently charged battery pack into the camera, or connect the camera to a wall outlet (wall socket) with the AC Adaptor (not supplied) and the USB/AV/DC IN cable for multi-use terminal (not supplied).

- When you copy images to your computer using a battery pack with little remaining charge, copying may fail or image data may become corrupted if the battery pack shuts down too soon.

3 Turn on the computer, then press the (Playback) button.

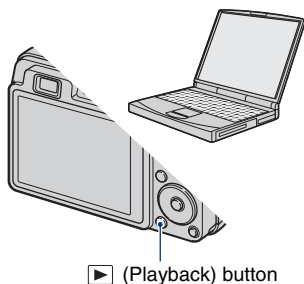

Connecting the camera to your computer

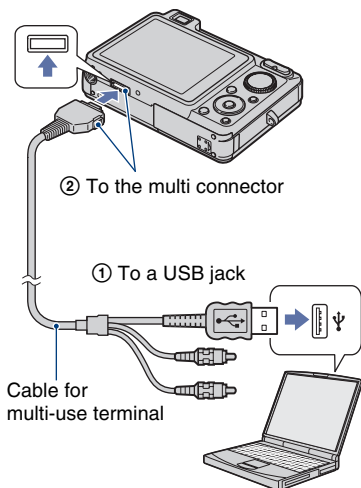

“Connecting...” appears on the screen of the camera.

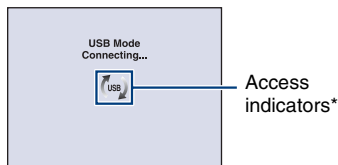

When a USB connection is established for the first time, your computer automatically runs a program to recognize the camera. Wait for a while.

*  is displayed on the screen during the communication session.

Do not operate the computer while the indicator is displayed. When the indicator changes to , you can start using the computer again.

- If “Mass Storage” does not appear, set [USB Connect] to [Mass Storage] (page 87).

Copying images to a computer

1 Connects the camera to a computer as described in “Connecting the camera to your computer”.

After making a USB connection, the [Import Media Files] screen of “Picture Motion Browser” appears automatically.



- If you use the Memory Stick slot, refer to page 107.
- If the AutoPlay Wizard appears, close it.

2 Import the images.

To start importing images, click the [Import] button.

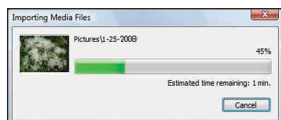

By default, images are imported into a folder created in “Pictures” (in Windows XP/2000, “My Pictures”) that is named with the date of importing.

- For details on the “Picture Motion Browser”, refer to “PMB Guide”.

Viewing images on your computer

When importing is complete, the “Picture Motion Browser” starts. Thumbnails of the imported images are displayed.

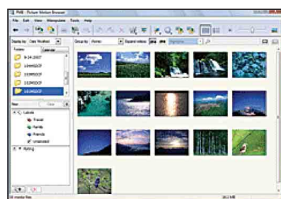

- The “Pictures” (in Windows XP/2000, “My Pictures”) folder is set as the default folder in “Viewed folders”.

Organize images on the computer on a calendar by shooting date to view them. For details, see the “PMB Guide”.

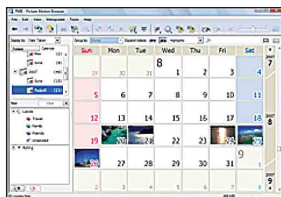

Example: Month display screen

To delete the USB connection

Perform the procedures from steps ① to ④ below before:

- Disconnecting the cable for multi-use terminal.
- Removing a “Memory Stick Duo”.
- Inserting a “Memory Stick Duo” into the camera after copying images from the internal memory.
- Turning off the camera.

- ① Double-click the disconnect icon on the taskbar.

Windows Vista



Double-click here

Windows XP/Windows 2000



Double-click here

- ② Click  (USB Mass Storage Device) → [Stop].
- ③ Confirm the device on the confirmation window, then click [OK].
- ④ Click [OK].
The device is disconnected.
- Step ④ is unnecessary for Windows Vista/XP.

Image file storage destinations and file names

The image files recorded with the camera are grouped as folders on the “Memory Stick Duo” or the internal memory.

Example: viewing folders on Windows Vista

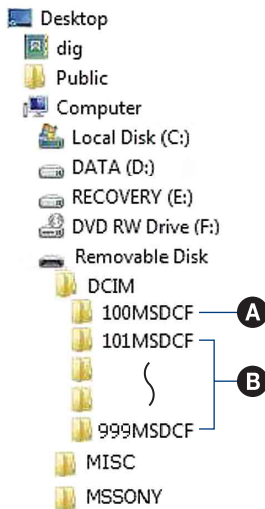

- A** Folder containing image data recorded using a camera not equipped with the folder creating function.
- B** Folder containing image data recorded using the camera.
When no new folders are created, there are folders as follows:
- “Memory Stick Duo”: “101MSDCF” only
 - Internal memory: “101_SONY” only

- You cannot record any images to the “100MSDCF” folder. The images in this folder are available only for viewing.
- You cannot record/play back any images to the “MISC” folder.
- Image files are named as follows:
 - Still image files: DSC0□□□□.JPG
 - Movie files: MOV0□□□□.MPG
 - Index image files that are recorded when you record movies: MOV0□□□□.THM□□□□ stands for any number within the range from 0001 to 9999. The numerical portions of the name of a movie file recorded in movie mode and its corresponding index image file are the same.
- For more information about folders, see pages 79 and 82.

Copying images to a computer without “Picture Motion Browser”

You can copy images to your computer without “Picture Motion Browser” as follows.

For a computer with a Memory Stick slot:

Remove the “Memory Stick Duo” from the camera and insert it in the Memory Stick Duo Adaptor. Insert the Memory Stick Duo Adaptor in the computer and copy the images.

- Even when you are using Windows 95/98/98 Second Edition/NT/Me, you can copy images by inserting the “Memory Stick Duo” into the Memory Stick slot on your computer.
- If the “Memory Stick PRO Duo” is not recognized, see page 126.

For a computer without a Memory Stick slot:

Make a USB connection and follow the following procedures to copy images.

- The screen displays shown in this section are the examples for copying images from “Memory Stick Duo”.
- The camera is not compatible with Windows 95/98/98 Second Edition/NT/Me of the Windows operating system. Use a commercially available Memory Stick Reader/Writer to copy images from a “Memory Stick Duo” to your computer. To copy images in the internal memory to your computer, copy the images to a “Memory Stick Duo” first, then copy them to your computer.

Copying images to a computer -Windows Vista/XP

This section describes an example of copying images to the “Documents” (For Windows XP: “My Documents”).

1 Prepare the camera and a computer.

Perform the same procedure as described in “Preparing the camera and the computer” on page 103.

2 Connect the camera to your computer with the cable for multi-use terminal.

Perform the same procedure as described in “Connecting the camera to your computer” on page 103.

- If “Picture Motion Browser” is already installed, then [Import Media Files] is started on “Picture Motion Browser” but select [Cancel] to finish.

- 3** Click [Open folder to view files] (For Windows XP: [Open folder to view files] → [OK]) as the wizard screen appears automatically on the desktop.



- When the wizard screen does not appear automatically, follow the procedure: → “For Windows 2000”.

- 4** Double-click [DCIM].

- 5** Double-click the folder where the image files you want to copy are stored. Then, right-click an image file to display the menu and click [Copy].

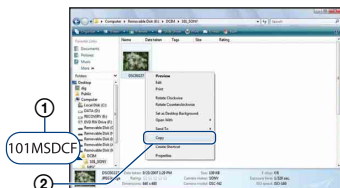

- On the storage destination of the image files, see page 105.

- 6** Click the [Documents] (For Windows XP: [My Documents]) folder. Then, right-click on the “Documents” window to display the menu and click [Paste].

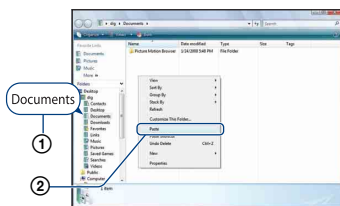

The image files are copied to the [Documents] (For Windows XP: [My Documents]) folder.

- When an image with the same file name exists in the copy destination folder, the overwrite confirmation message appears. When you overwrite an existing image with a new one, the original file data is deleted. To copy an image file to the computer without overwriting, change the file name and then copy the image file. However, note that if you change the file name (page 109), you may not play back that image with the camera.

For Windows 2000

Double-click [My Computer] → [Removable Disk] after connecting the camera to your computer. Then, perform from step 4.

Viewing image files stored on a computer with the camera copying to the “Memory Stick Duo”

This section describes the process using a Windows computer as an example. When an image file copied to a computer no longer remains on a “Memory Stick Duo”, you can view that image again on the camera by exporting (copying) the image file to the camera using the “Picture Motion Browser”.

- You may not be able to play back some images depending on the image size.
- Sony does not guarantee playback of image files on the camera if the files have been processed using a computer or recorded with another camera.

1 Connect the camera to your computer and start up the “Picture Motion Browser” (pages 102, 103).

2 Select the still images to be exported on the main window.

3 From the [Manipulate] menu, select [Open with External Program] → [Image Export Tool].

4 Thereafter, follow the instructions on the screen and export the image files to the “Memory Stick Duo”.

- For details on “Picture Motion Browser”, see “PMB Guide”.
-

To export images to the camera without using the “Picture Motion Browser”

- Images copied by the procedure below cannot be played back using Date View, Filter by Faces, or cannot be registered to Favorites. Play back these images on the camera using Folder View (page 68).
- Skip steps ① and ② if the file name set with your camera has not been changed.

- ① Right-click the image file, then click [Rename].
 - ② Change the file name to “DSC0□□□□”. Enter a number from 0001 to 9999 for □□□□.
 - If the overwrite confirmation message appears, enter a different number.
 - An extension may be displayed depending on the computer settings. The extension for still images is JPG, and the extension for movies is MPG. Do not change the extension.
 - ③ Right-click the image file, then click [Copy].
 - ④ Double-click [Removable Disk] or [Sony MemoryStick] in [Computer] (in Windows XP, [My Computer]).
 - ⑤ Right-click the [□□□MSDCF] folder in the [DCIM] folder, then click [Paste].
 - □□□ stands for any number within the range from 100 to 999.
- When there are no folders in a “Memory Stick Duo”, create a folder (page 82) with the camera first, then copy the image files.

Using the “Music Transfer” (supplied)

You can change the Music files that are preset at the factory to the desired Music files using “Music Transfer” in the CD-ROM (supplied). You can also delete or add these files whenever you want.

Adding/Changing Music using “Music Transfer”

The music formats you can transfer with “Music Transfer” are listed below:

- MP3 files stored on the hard disk drive of your computer
- Music on CDs
- Preset-music saved on the camera

- To restore the music preset at the factory to the camera:





① Perform [Format Music] in step 3.

② Execute [Restore defaults] on “Music Transfer”.

All Music files return to the preset-music, and [Music] in the [Slideshow] menu is set to [Off].

- You can reset the Music files to the preset ones using [Initialize] (page 85), however, other settings will also be reset.
- For details on using “Music Transfer”, see the on-line help in “Music Transfer”.

1 Press the HOME button to display the HOME screen.

2 Select  (Slideshow) with  on the control button, select  Music Tool] with , then press .

3 Select [Download Music] with , then press .

The message “Connect to PC” appears.

4 Make a USB connection between the camera and your computer.

5 Start “Music Transfer”.

6 Follow the instructions on the screen to add/change Music files.

Using your Macintosh computer

You can copy images to your Macintosh computer.

- “Picture Motion Browser” is not compatible with Macintosh computers.

Recommended computer environment

The following environment is recommended for a computer connected to the camera.

Recommended environment for copying images

OS (pre-installed): Mac OS 9.1/9.2/ Mac OS X(v10.1 to v10.5)

USB jack: Provided as standard

Recommended environment for using “Music Transfer”

OS (pre-installed): Mac OS X (v10.3 to v10.5)

CPU: iMac, eMac, iBook, PowerBook, Power Mac G3/G4/G5 series, Mac mini

Memory: 64 MB or more (128 MB or more is recommended)

Hard Disk: Disk space required for installation—approximately 250 MB

Notes on connecting the camera to a computer

- Operations are not guaranteed for all the recommended computer environments mentioned above.
- If you connect two or more USB devices to a single computer at the same time, some devices, including the camera, may not operate depending on the types of USB devices you are using.
- Operations are not guaranteed when using a USB hub.
- Connecting the camera using a USB interface that is compatible with Hi-Speed USB (USB 2.0 compliant) allows advanced transfer (high speed transfer) as the camera is compatible with Hi-Speed USB (USB 2.0 compliant).

- There are four modes for a USB connection when connecting a computer, [Auto] (default setting), [Mass Storage], [PictBridge] and [PTP/MTP] modes. This section describes the [Auto] and [Mass Storage] as examples. For details on [PictBridge] and [PTP/MTP], see page 87.
- When your computer resumes from the suspend or sleep mode, communication between the camera and your computer may not recover at the same time.

Copying and viewing images on a computer

1 Prepare the camera and a Macintosh computer.

Perform the same procedure as described in “Preparing the camera and the computer” on page 103.

2 Connect the camera to your computer with the cable for multi-use terminal.

Perform the same procedure as described in “Connecting the camera to your computer” on page 103.

3 Copy image files to the Macintosh computer.

- ① Double-click the newly recognized icon → [DCIM] → the folder where the images you want to copy are stored.
 - ② Drag and drop the image files to the hard disk icon.
The image files are copied to the hard disk.
- For details on the storage location of the images and file names, see page 105.

4 View images on the computer.

Double-click the hard disk icon → the desired image file in the folder containing the copied files to open that image file.

To delete the USB connection

Drag and drop the drive icon or the icon of the “Memory Stick Duo” to the “Trash” icon beforehand when you perform the procedures listed below, or the camera is disconnected from the computer.

- Disconnecting the cable for multi-use terminal.
- Removing a “Memory Stick Duo”.
- Inserting a “Memory Stick Duo” into the camera after copying images from the internal memory.
- Turning off the camera.

Adding/Changing Music using “Music Transfer”

You can change the Music files that are preset at the factory to the desired Music files. You can also delete or add these files whenever you want.

The music formats you can transfer with “Music Transfer” are listed below:

- MP3 files stored on the hard disk drive of your computer
- Music on CDs
- Preset-music saved on the camera

To install “Music Transfer”

- Shut down all other application software before you install “Music Transfer”.
- For installation, you need to log on as Administrator.
 - ① Turn on your Macintosh computer, and insert the CD-ROM (supplied) into the CD-ROM drive.
 - ② Double-click  (SONYPICTUTIL).
 - ③ Double-click the [MusicTransfer.pkg] file in [MAC] folder.

The installation of the software starts.

To add/change Music files

See “Adding/Changing Music using “Music Transfer”” on page 110.

Technical Support

Additional information on this product and answers to frequently asked questions can be found at the Sony Customer Support Website.
<http://www.sony.net/>

Viewing “Cyber-shot Step-up Guide”

When you install “Cyber-shot Handbook”, “Cyber-shot Step-up Guide” is also installed. “Cyber-shot Step-up Guide” further introduces how to use the camera and optional accessories.

Viewing on Windows

Double-click  (Step-up Guide) on the desktop.

To access “Step-up Guide” from the Start menu, click [Start] → [All Programs] (in Windows 2000, [Programs]) → [Sony Picture Utility] → [Step-up Guide].

Viewing on Macintosh

- 1 Copy the [stepupguide] folder in the [stepupguide] folder to your computer.**
- 2 Select [stepupguide], [language] and then [GB] folder stored in the CD-ROM (supplied), and copy all the files in the [GB] folder to the [img] folder in the [stepupguide] folder that you copied to your computer in step 1. (Overwrite the files in the [img] folder with the files from the [GB] folder.)**
- 3 After copying is complete, double-click “stepupguide.hqx” in the [stepupguide] folder to uncompress it, then double-click the generated file “stepupguide”.**

- If an uncompress tool for HQX file is not installed, install the Stuffit Expander.



How to print still images

When you print images shot in [16:9] mode, both edges may be cut off, so be sure to check before printing (page 128).

Printing directly using a PictBridge compliant printer (page 115)



You can print images by connecting the camera directly to a PictBridge compliant printer.

Printing directly using a “Memory Stick” compliant printer



You can print images with a “Memory Stick” compliant printer. For details, see the operating instructions supplied with the printer.

Printing using a computer



You can copy images to a computer using the supplied “Picture Motion Browser” software and print the images.

You can insert the date on the image and print it (page 102).

Printing at a shop (page 118)



You can take a “Memory Stick Duo” containing images shot with the camera to a photo printing service shop. You can make a **DPOF** (Print order) mark on the images which you want to print out in advance.

Printing images directly using a PictBridge compliant printer

Even if you do not have a computer, you can print images shot using the camera by connecting the camera directly to a PictBridge compliant printer.

PictBridge

- “PictBridge” is based on the CIPA standard. (CIPA: Camera & Imaging Products Association)
- You cannot print movies.
- If the  indicator flashes on the screen of the camera (error notification), check the connected printer.





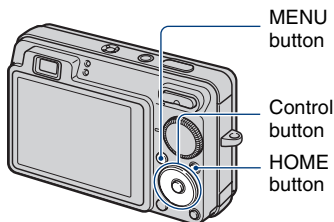

Stage 1: Preparing the camera

Prepare the camera for connection to the printer, using the cable for multi-use terminal. When [USB Connect] is set to [Auto], the camera will automatically recognize certain printers when connected. Skip Stage 1, if this is the case.



- It is recommended to use a fully charged battery pack to prevent the power from turning off partway through printing.

1 Press the HOME button to display the HOME screen.

2 Select  (Settings) with /  on the control button, and select [Main Settings] with / , then press .

3 Select [Main Settings 2] with / , and select [USB Connect], then press .

4 Select [PictBridge] with / , then press .

The USB mode is set.

Stage 2: Connecting the camera to the printer

- 1 Connect the camera to the printer.

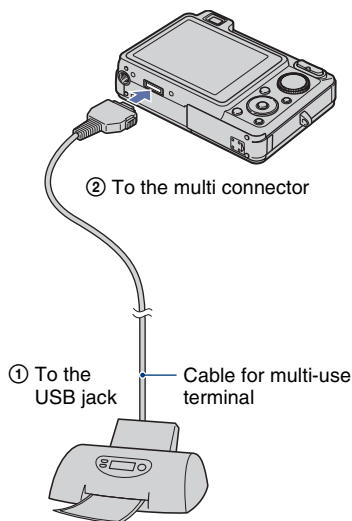

- 2 Turn on the printer. Press the (Playback) button and turn on the camera.

After the connection is made, the indicator appears.



- 3 Press the MENU button, select [Print] with $\blacktriangle/\blacktriangledown$ on the control button, then press \bullet .

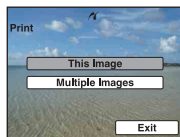

The camera is set to playback mode, then an image and the print menu appear on the screen.

Stage 3: Selecting images you want to print

Select [This Image] or [Multiple Images] with $\blacktriangle/\blacktriangledown$, then press \bullet .

When you select [This Image]

You can print the selected image. Move on to Stage 4.

When you select [Multiple Images]

You can print multiple selected images.

- ① Select the image you want to print with $\blacktriangle/\blacktriangledown/\blacktriangleleft/\blacktriangleright$, then press \bullet .
 appears on the selected image.
 - ② Press the MENU button to display the menu.
 - ③ Select [OK] with \blacktriangle , then press \bullet .
- To print all the images of a date/folder/favorites, select [Multiple Images] on the index screen, select the bar with \blacktriangleleft , and place a mark in the check box.

Stage 4: Printing

1 Select print settings with ▲/▼/◀/▶.

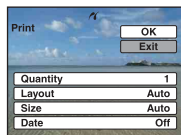

[Quantity]

Selects the number of copies of the specified image to be printed.

- The designated number of images may not all fit onto a single sheet depending on the quantity of images.

[Layout]

Selects the number of image you want to print side by side on a sheet.

[Size]

Selects the size of the printing sheet.

[Date]

Selects [Day & Time] or [Date] to insert the date and time on images.

- When you choose [Date], the date will be inserted in the order you select (page 93). This function may not be provided depending on the printer.

2 Select [OK] with ▲, then press ●.

The image is printed.

- Do not disconnect the cable for multi-use terminal while the  (PictBridge Connecting) indicator appears on the screen.

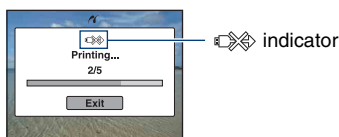

Stage 5: Completing the printing

Make sure the screen has returned to Stage 2, and disconnect the cable for multi-use terminal from the camera.

Printing at a shop

You can take a “Memory Stick Duo” containing images shot with the camera to a photo printing service shop. As long as the shop supports photo printing services conforming to the DPOF, you can make a **DPOF** (Print order) mark on images in advance so that you do not need to reselect them when you print them out at the shop.

- You cannot print images stored in the internal memory at a print shop directly from the camera. Copy the images to a “Memory Stick Duo”, then take the “Memory Stick Duo” to the print shop.

What is DPOF?

DPOF (Digital Print Order Format) is a function allowing you to make a **DPOF** (Print order) mark on images of “Memory Stick Duo” that you want to print out later.

- You can also print the images with the **DPOF** (Print order) mark using a printer that conforms to the DPOF (Digital Print Order Format) standard or using a PictBridge compliant printer.
- You cannot mark movies.
- You can make a **DPOF** (Print order) mark on up to 999 images.

When taking a “Memory Stick Duo” to a shop

- Consult your photo printing service shop as to what types of “Memory Stick Duo” they handle.
- If a “Memory Stick Duo” is not handled by your photo printing service shop, copy the images you want to print out to another medium such as a CD-R and take it to the shop.
- Be sure to take the Memory Stick Duo Adaptor with it.
- Before you take image data to a shop, always copy (back up) your data to a disk.
- You cannot set the number of prints.
- When you want to superimpose dates on images, consult your photo printing service shop.



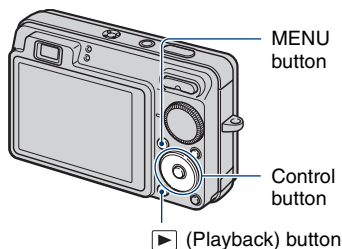

Marking a selected image



1 Press the  (Playback) button.

2 Select the image you want to print.

3 Press the MENU button to display the menu.

4 Select [DPOF] with / on the control button and select [This Image] with /, then press .

The DPOF (Print order) mark is attached to the image.



To remove the mark

Select the images from which you want to remove the mark, then repeat steps 3 and 4.

Selecting and marking the images

1 Press the MENU button while displaying images in single-image mode or in index mode.

2 Select [DPOF] with ▲/▼ on the control button, [Multiple Images] with ◀/▶, and then press ●.

3 Select an image to mark with the control button, then press ●.

The ✓ mark is attached to the selected image.

Single-Image



Index Display



4 Press the MENU button.

5 Select [OK] with ▲, then press ●.

The DPOF mark appears on the screen.

Single-Image



Index Display



To cancel the selection

Select [Exit] in step 5, then press ●.

To remove the mark

Select the images that you want to remove the marks, then press ● in step 3.

To mark all the images of a date/folder/ favorites

To mark all the images of a date/folder/ favorites, select [Multiple Images] on the index screen, select the bar with ◀, and place a ✓ mark in the check box.

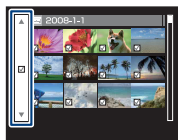



If you experience trouble with the camera, try the following solutions.

1 Check the items on pages 121 to 130.

If a code such as “C/E:□□:□□” appears on the screen, see page 131.

2 Remove the battery pack, wait for about one minute, re-insert the battery pack, then turn on the power.

3 Initialize the settings (page 85).

4 Consult your Sony dealer or local authorized Sony service facility.

Be aware that by sending the camera for repair, you give consent that the contents of the internal memory, Music files may be checked.

Click one of the following items to jump to the page explaining the symptom and cause or the appropriate corrective action.

Battery pack and power 121

“Memory Stick Duo” 127

Shooting still images/movies 121

Internal memory 127

Viewing images 125

Printing 128

Deleting 125

PictBridge compliant printer 128

Computers 126

Others 129

Battery pack and power

Cannot insert the battery pack.

- Insert the battery pack correctly to push the battery eject lever.

Cannot turn on the camera.

- After inserting the battery pack into the camera, it may take a few moments for the camera to power up.
- Insert the battery pack correctly.
- The battery pack is discharged. Insert a charged battery pack.
- The battery pack is dead (page 138). Replace it with a new one.
- Use a recommended battery pack.

The power turns off suddenly.

- If you do not operate the camera for about three minutes while the power is on, the camera turns off automatically to prevent wearing down the battery pack. Turn on the camera again.
- The battery pack is dead (page 138). Replace it with a new one.

The remaining charge indicator is incorrect.



- This phenomenon occurs when you use the camera in an extremely hot or cold location.
- A discrepancy arose between the remaining charge indicator and the actual remaining battery charge. Fully discharge the battery pack once, then charge it to correct the indication.
- The battery pack is discharged. Insert a charged battery pack.
- The battery pack is dead (page 138). Replace it with a new one.

Cannot charge the battery pack.

- You cannot charge the battery pack using the AC Adaptor (not supplied). Use the battery charger (supplied) to charge the battery.

Shooting still images/movies

Cannot record images.

- Check the free capacity of the internal memory or “Memory Stick Duo”. If it is full, do one of the following:
 - Delete unnecessary images (page 42).
 - Change the “Memory Stick Duo”.
- You cannot record images while charging the flash.
- When shooting a still image, set the mode dial to a position other than .
- Set the mode dial to  when shooting movies.
- The image size is set to [640(Fine)] when recording movies. Do one of the following:
 - Set the image size to other than [640(Fine)].
 - Insert a “Memory Stick PRO Duo”.

Cannot shoot in Smile Shutter mode.

- Press the shutter button all the way down.
- No image is shot unless a smile is detected (page 32).
- [Smile demo mode] is set to [On]. Set [Smile demo mode] to [Off] (page 86).

This subject is not visible on the screen.

- The camera is set to the playback mode. Press the  (Playback) button to change to the recording mode (page 36).



Anti-blur function does not work.

- The anti-blur function does not work when  appears on the display.
- The anti-blur function may not work properly when shooting night scenes.
- Shoot after pressing the shutter button halfway down; do not press it fully down suddenly.
- Confirm that the [Conversion Lens] setting is correct (page 91).



Recording takes a long time.

- The NR slow shutter function is activated (page 17). This is not a malfunction.
- [DRO] is set to [DRO plus] (page 63). This is not a malfunction.











The image is out of focus.

- The subject is too close. Make sure to position the lens farther away from the subject than the shortest shooting distance, approximately 5 cm (2 inches) (W)/34 cm (1 foot 1 1/2 inches) (T) (from the front of the lens), when shooting (page 25).
-  (Landscape) mode,  (Twilight) mode or  (Fireworks) mode is selected in the Scene Selection mode when shooting still images.
- The Semi manual function is selected. Select the auto focus mode (page 58).
- Confirm that the [Conversion Lens] setting is correct (page 91).
- Refer to “If the subject is out of focus” on page 59.

Zoom does not work.

- You cannot use the Smart zoom depending on the image size (page 90).
- When  (Extra High Sensitivity) mode or  (Extra High-speed Burst) mode is selected in the Scene Selection mode, the Smart zoom does not function.
- You cannot use the Digital Zoom when shooting movies.
- You cannot change the zoom scale when:
 - The Smile Shutter is in standby (page 32).
 - Shooting movies.
- Confirm that the [Conversion Lens] setting is correct (page 91).



The flash does not work.

- The flash is set to  (Flash forced off) (page 26).
- You cannot use the flash when:
 - [REC Mode] is set to [Burst] or Exposure Bracket (page 53).
 -  (High Sensitivity) mode,  (Extra High Sensitivity) mode,  (Extra High-speed Burst) mode,  (Twilight) mode or  (Fireworks) mode is selected in the Scene Selection mode (page 31).
 - Shooting movies.
- Set the flash to  (Flash forced on) when the mode dial is set to M, or when  (Landscape) mode,  (Beach) mode,  (Snow) mode, or  (Underwater) mode is selected in the Scene Selection mode (page 26).

Fuzzy white circular spots appear in images shot using the flash.

- Particles (dust, pollen, etc.) in the air reflected the flash light and appeared in the image. This is not a malfunction (page 13).

The close-up shoot function (Macro) does not work.

-  (Landscape) mode,  (Twilight) mode or  (Fireworks) mode is selected in the Scene Selection mode (page 31).

Macro shooting cannot be released.

- There is no function for releasing a macro. In  (Auto) mode, telephoto shooting is possible even in the macro shooting condition.

The date and time are not displayed on the LCD screen.

- While shooting, the date and time are not displayed. They are displayed only during playback.

Cannot insert dates on image.

- The camera does not have a feature for superimposing dates on images (page 128). By using “Picture Motion Browser”, you can print or save images with the date (page 102).

The F value and shutter speed flash when you press and hold the shutter button halfway down.

- The exposure is incorrect. Correct the exposure (page 55).

The screen is too dark or too bright.

- Adjust the brightness of the LCD backlight (page 20).

The image is too dark.

- You are shooting a subject with a light source behind the subject. Select the metering mode (page 57) or adjust the exposure (page 55).

The image is too bright.

- Adjust the exposure (page 55).
-

The image colors are not correct.

- Set [Color Mode] to [Normal] (page 64).
 - Set [Color Filter] to [Off] (page 65).
-

Vertical streaks appear when you are shooting a very bright subject.

- The smear phenomenon is occurring and white, black, red, purple, or other streaks appear on the image. This phenomenon is not a malfunction.
-

The whole image becomes reddish when you shoot something bright.

- This phenomenon is called smear. It may occur in the M or  (Soft Snap) mode, etc., when the shutter speed is fast or when the F value is small. There is no effect on the recorded image.
-

Noise appears in the image when you view the screen in a dark place.

- The camera is attempting to increase the visibility of the screen by temporarily brightening the image under conditions of low illumination. There is no effect on the recorded image.
-

The eyes of the subject come out red.

- Set [Red Eye Reduction] to [On] (page 63).
 - Shoot the subject at a distance closer than the flash range using the flash.
 - Light the room and shoot the subject.
 - Retouch the image using [Red Eye Correction] (page 72).
-

Dots appear and remain on the screen.

- This is not a malfunction. These dots are not recorded (page 2).
-

The image seen through the finder does not match with the actual recordable range.

- The parallax phenomenon is occurring when the subject is close. In this case, to confirm the recordable range, use the LCD screen.
 - Images cannot be confirmed through the finder while the digital zoom is in use.
-

Cannot shoot images in succession.

- The internal memory or “Memory Stick Duo” is full. Delete unnecessary images (page 42).
 - The battery level is low. Insert the charged battery pack.
-

The same image is shot several times.

- [REC Mode] is set to [Burst]. Or, [Scene Recognition] is set to [Advanced] (pages 53, 54).

Viewing images

Cannot play back images.

- Press the  (Playback) button (page 36).
- The folder/file name has been changed on your computer (page 109).
- Sony does not guarantee playback of image files on the camera if the files have been processed using a computer or recorded with another camera.
- The camera is in USB mode. Delete the USB connection (page 105).
- Playback is impossible if the Smile Shutter is in standby mode. Exit standby mode by pressing the shutter button all the way down.
- This is caused by copying images on the PC to the “Memory Stick Duo” without using the “Picture Motion Browser” (page 109). Play such images in Folder View (page 68).
- Sometimes a “Memory Stick Duo” containing images shot with earlier Sony models cannot be played back. Play such images in Folder View (page 68).

The date and time are not displayed.

- The display indicators are turned off. Show the display indicators by pressing  (DISP) on the control button (page 20).

The image appears rough right after playback starts.

- This may happen due to image processing. This is not a malfunction.

Left and right sides of the screen are shown in black.

- [Auto Orientation] is set to [On] (page 92).

Cannot hear music during slideshow.

- Transfer music files to the camera with “Music Transfer” (page 110).
- Confirm that the volume setting and slideshow setting are correct (page 38).

The image does not appear on the TV screen.

- Check [Video Out] to see if the video output signal of the camera is set to the color system of your TV (page 88).
- Check whether the connection is correct (page 95).
- If the USB connector of the cable for multi-use terminal is connected to another device, disconnect it (page 105).
- You are trying to play back movies during HD(1080i) output. Movies cannot be viewed at high-definition image quality. Set [COMPONENT] to [SD] (page 87).

Deleting

Cannot delete an image.

- Cancel the protection (page 77).

Computers

Computer OS compatibility with camera is unknown.

- Check “Recommended computer environment” on page 99 for Windows, and page 111 for Macintosh.

“Memory Stick PRO Duo” is not recognized by a computer with a “Memory Stick” slot.

- Check that the computer and the Memory Stick Reader/Writer support “Memory Stick PRO Duo”. Users of computers and Memory Stick Readers/Writers made by manufacturers other than Sony should contact those manufacturers.
- If “Memory Stick PRO Duo” is not supported, connect the camera to the computer (pages 103, 111). The computer recognizes the “Memory Stick PRO Duo”.

Your computer does not recognize the camera.

- Turn on the camera.
- When the battery level is low, insert the charged battery pack or use the AC Adaptor (not supplied) (page 103).
- Set [USB Connect] to [Mass Storage] (page 87).
- Use the cable for multi-use terminal (supplied) (page 103).
- Disconnect the cable for multi-use terminal from both the computer and the camera, and connect it again firmly.
- Disconnect all equipment other than the camera, the keyboard and the mouse from the USB connectors of your computer.
- Connect the camera directly to your computer without passing through a USB hub or other device (page 103).

Cannot copy images.

- Connect the camera and your computer correctly making a USB connection (page 103).
- Follow the designated copy procedure for your OS (pages 107, 111).
- When you shoot images with a “Memory Stick Duo” formatted by a computer, you may not be able to copy the images to a computer. Shoot using a “Memory Stick Duo” formatted by the camera (page 82).

After making a USB connection, “Picture Motion Browser” does not start automatically.

- Make the USB connection after the computer is turned on (page 103).

Cannot play back images on your computer.

- If you are using “Picture Motion Browser”, refer to “PMB Guide” (page 102).
- Consult the computer or software manufacturer.

You do not know how to use “Picture Motion Browser”.

- Refer to “PMB Guide” (page 102).

The image and sound are interrupted by noise when you view a movie on a computer.

- You are playing back the movie directly from the internal memory or the “Memory Stick Duo”. Copy the movie to the hard disk of your computer, then play back the movie from the hard disk (page 103).

Cannot print an image.

- Refer to the operation manual of the printer.

Images once copied to a computer cannot be viewed on the camera.

- Copy them to a folder recognized by the camera, such as “101MSDCF” (page 105).
- Follow the correct procedures (page 109).
- When you copy images to a computer without using “Picture Motion Browser”, the images are not displayed in Date View mode. View the images in Folder View mode.

“Memory Stick Duo”

Cannot insert a “Memory Stick Duo”.

- Insert it in the correct direction.

You have formatted a “Memory Stick Duo” by mistake.

- All the data on the “Memory Stick Duo” is deleted by formatting. You cannot restore it.

Internal memory

Cannot playback or record images using the internal memory.

- There is a “Memory Stick Duo” inserted in the camera. Remove it.

Cannot copy the data stored in the internal memory to a “Memory Stick Duo”.

- The “Memory Stick Duo” is full. Copy the image to the “Memory Stick Duo” with sufficient free capacity.

Cannot copy the data on the “Memory Stick Duo” or the computer to the internal memory.

- This feature is not available.

Printing

See “PictBridge compliant printer” together with the following items.

Images are printed with both edges cut off.

- Depending on your printer, all the edges of the image may be cut off. Especially when you print an image shot with the image size set to [16:9], the lateral end of the image may be cut off.
- When printing images using your printer, cancel the trimming or borderless settings. Consult the printer manufacturer as to whether the printer provides these functions or not.
- When having images printed at a digital print shop, ask the shop whether they can print the images without cutting off both edges.

Cannot print images with the date.

- Using “Picture Motion Browser”, you can print images with date (page 102).
- The camera does not have a feature for superimposing dates on images. However, because the images shot with the camera include information on the recording date, you can print images with the date superimposed if the printer or the software can recognize Exif information. For compatibility with Exif information, consult the manufacturer of the printer or the software.
- If you use a photo printing service, ask them to superimpose the dates on images.

PictBridge compliant printer

A connection cannot be established.

- The camera cannot be connected directly to a printer that is not compliant with the PictBridge standard. Consult the printer manufacturer as to whether the printer is compliant with PictBridge or not.
- Check that the printer is turned on and can be connected to the camera.
- Set [USB Connect] to [PictBridge] (page 87).
- Disconnect and connect the cable for multi-use terminal again. If an error message is indicated on the printer, refer to the operating instructions supplied with the printer.

Cannot print images.

- Check that the camera and the printer are properly connected using the cable for multi-use terminal.
- Turn on the printer. For further information, refer to the operating instructions supplied with the printer.
- If you select [Exit] during printing, images may not be printed. Disconnect and connect the cable for multi-use terminal again. If you still cannot print your images, disconnect the cable for multi-use terminal, turn the printer off and then on, then connect the cable for multi-use terminal again.
- Movies cannot be printed.
- Images shot using cameras other than the camera or images modified with a computer may not be printed.

Printing is canceled.

- Confirm that you have disconnected the cable for multi-use terminal before the  (PictBridge Connecting) mark disappears.

Cannot insert the date or print images in the index mode.

- The printer does not provide these functions. Consult the printer manufacturer as to whether the printer provides these functions or not.
- The date may not be inserted in the index mode depending on the printer. Consult the printer manufacturer.

“---- -- --” is printed on the date-inserted part of the image.

- The image does not have the recording data so the date cannot be inserted. Set [Date] to [Off] and print the image again (page 117).

Cannot select the print size.

- Consult the printer manufacturer as to whether the printer can provide the desired size.

Cannot print the image at the size selected.

- When you use paper of a different size after connecting the printer to the camera, disconnect and then reconnect the cable for multi-use terminal.
- The print setting of the camera differs from that of the printer. Change the setting of either the camera (page 117) or the printer.

Cannot operate the camera after canceling printing.

- Wait for a while as the printer is carrying out the cancellation. It may take some time depending on the printer.

Others

Cannot reset the file-number.

- If you replace a recording medium, you cannot initialize file numbers with the camera. To initialize file numbers, perform [Format] (pages 82, 84), and then perform [Initialize] (page 85). However, the data on the “Memory Stick Duo” or the internal memory will be deleted and all settings, including date, will be initialized.

The camera does not function with the lens portion extended.

- Do not attempt to force the lens that has stopped moving.
- Insert a charged battery pack, then turn on the camera again.
- Never remove the battery pack/“Memory Stick Duo” when the access lamp is lit. This may cause damage to data in the “Memory Stick Duo”/internal memory.

The lens gets fogged.

- Moisture condensation has occurred. Turn off the camera and leave it for about an hour before using it.
-

The lens does not move when you turn off the camera.

- The battery pack is discharged. Replace it with a charged battery pack.
-

The camera becomes warm when you use it for a long time.

- This is not a malfunction.
-

The Clock Set screen appears when you turn on the camera.

- Set the date and time again (page 93).
 - The internal rechargeable backup battery has discharged. Insert a charged battery and set aside for 24 hours or more with the power left off.
-

You want to change the date or time.

- Set the date and time again (page 93).

Warning indicators and messages

Self-diagnosis display

If a code starting with a letter of the alphabet appears, the self-diagnosis function on the camera is working. The last two digits (indicated by □□) will differ depending on the state of the camera. If you cannot solve the problem even after trying the following corrective actions a few times, the camera may need repair. Contact your Sony dealer or local authorized Sony service facility.

C:32:□□

- There is trouble with the camera's hardware. Turn the power off and on again.

C:13:□□

- The camera cannot read or write data on the "Memory Stick Duo". Try turning off and on the camera again, or taking out and inserting the "Memory Stick Duo" several times.
- The internal memory has experienced a format error, or an unformatted "Memory Stick Duo" is inserted. Format the internal memory or the "Memory Stick Duo" (pages 82, 84).
- The inserted "Memory Stick Duo" cannot be used with the camera, or the data is damaged. Insert a new "Memory Stick Duo".

E:61:□□

E:62:□□

E:91:□□

- A camera malfunction has occurred. Initialize the camera (page 85), then turn the power on again.

Messages

If the following messages appear, follow the instructions.



- The battery level is low. Charge the battery pack immediately. Depending on the conditions of use or the type of battery pack, the indicator may flash even though there are still 5 to 10 minutes of remaining battery time left.

For use with compatible battery only

- The battery inserted is not an NP-BG1 battery pack (supplied) or NP-FG1 battery pack (not supplied).

System error

- Turn the power off and then on again.

Internal memory error

- Turn the power off and then on again.

Reinsert the Memory Stick

- Insert the "Memory Stick Duo" correctly.
- The inserted "Memory Stick Duo" cannot be used in the camera (page 136).
- The "Memory Stick Duo" is damaged.
- The terminal section of the "Memory Stick Duo" is dirty.

Memory Stick type error

- The inserted "Memory Stick Duo" cannot be used in the camera (page 136).

Cannot access Memory Stick Access denied

- You are using the “Memory Stick Duo” with the access controlled.

Error formatting Memory Stick Error formatting internal memory

- Format the media again (pages 82, 84).

Memory Stick locked

- You are using the “Memory Stick Duo” with the write-protect switch, and the switch is set to the LOCK position. Set the switch to the recording position.

No memory space on internal memory

No memory space on Memory Stick

- Delete unnecessary images or files (page 42).

Read only memory

- The camera cannot record or delete images on this “Memory Stick Duo”.

No images

- No images that can be played back have been recorded in the internal memory.
- No images that can be played back have been recorded on the “Memory Stick Duo”
- The selected folder does not contain a file that can be played back in a slideshow.

Folder error

- A folder with the same first three digit number already exists on the “Memory Stick Duo” (for example: 123MSDCF and 123ABCDE). Select another folder, or create a new folder (pages 82, 83).

Cannot create more folders

- The folder with a name beginning with “999” exists on the “Memory Stick Duo”. You cannot create any folders if this is the case.

File error

- An error occurred while the image was playing back. Sony does not guarantee playback of image files on the camera if the files have been processed using a computer or recorded with another camera.

Read only folder

- You have selected a folder that cannot be set as a recording folder on the camera. Select another folder (page 83).

File protected

- Release the protection (page 77).

Image size over limit

- You are playing back an image with size that cannot be played back on the camera.

(Vibration warning indicator)

- Camera shake may occur due to insufficient light. Use the flash, turn on the anti-blur function, or mount the camera on a tripod to secure the camera.

640(Fine) is not available

- 640(Fine) size movies can be recorded only using a “Memory Stick PRO Duo”. Insert a “Memory Stick PRO Duo” or set the image size to a size other than [640(Fine)].

Macro is invalid

- The macro is unavailable under the current settings (page 31).

Flash settings cannot be changed

- The flash is unavailable under the current settings (page 31).

Maximum number of images already selected

- You can select up to 100 image files from [Multiple Images].
- When you select all image files of a date/folder/favorites, the maximum number is 999.
- You can add up to 999 image files as Favorites, and you can add the **DPOF** (Print order) mark to a maximum 999 files. Cancel the selection.

Low battery power

- When copying an image recorded in the internal memory to the "Memory Stick Duo", use a fully charged battery.

Printer busy

Paper error

No paper

Ink error

Low ink

No ink

- Check the printer.

Printer error

- Check the printer.
- Check if the image you want to print is corrupted.



- The data transmission to the printer may not be completed yet. Do not disconnect the cable for multi-use terminal.

Processing...

- The printer is canceling the current print job. You cannot print until it is finished. This may take time, depending on the printer.
- If you select all image files of a date/folder/favorites, this may take time for processing.

Error Playing Music

- Delete the Music file, or replace it with a normal Music file.
- Execute [Format Music], then download a new Music file.

Error Formatting Music

- Execute [Format Music].

Operation cannot be executed for movie files

- You have selected a function that is not available for movies.

Operation cannot be executed in unsupported files

- Processing and other editing functions of the camera cannot be performed on image files that have been processed using a computer or images that were recorded with another camera.

Operation cannot be executed when using a PictBridge connection

- Some functions are restricted while the camera is connected to a PictBridge compliant printer.

Operation cannot be executed during HD(1080i) output

- Some functions are restricted while the camera is connected to a High Definition TV.

Unable to detect face for retouch

- Retouching may not be possible depending on the image.
-

Turn the power off and on again

- The lens malfunction.
-

Self-Timer is invalid

- The self-timer is unavailable under these settings (page 31).
-

Recover data

Recovering data

- Date information or other data is recovered in cases where images have been deleted on the PC.
-



- The number of images exceeds that for which date management by the camera is possible (less than 20,000). Delete images from the Date View.



You can use the camera, the battery charger (supplied), and the AC-LS5K AC Adaptor (not supplied) in any country or region where the power supply is within 100 V to 240 V AC, 50/60 Hz.

- **Do not use an electronic transformer (travel converter), as this may cause a malfunction.**

On the “Memory Stick Duo”

A “Memory Stick Duo” is a compact, portable IC recording medium. The types of “Memory Stick Duo” that can be used with the camera are listed in the table below. However, proper operation cannot be guaranteed for all “Memory Stick Duo” functions.

| “Memory Stick” type | Recording/ Playback |
|-----------------------------------------|------------------------|
| Memory Stick Duo (without MagicGate) | ○*1 |
| Memory Stick Duo (with MagicGate) | ○*2 |
| MagicGate Memory Stick Duo | ○*1*2 |
| Memory Stick PRO Duo | ○*2*3 |
| Memory Stick PRO-HG Duo | ○*2*3*4 |

*1) The camera is not compatible with high-speed data transfer using a parallel interface.

*2) “Memory Stick Duo”, “MagicGate Memory Stick Duo” and “Memory Stick PRO Duo” are equipped with MagicGate functions. MagicGate is copyright protection technology that uses encryption technology. Data recording/playback that requires MagicGate functions cannot be performed with the camera.

*3) [640(Fine)] size movies can be recorded.

*4) The camera is not compatible with 8-bit parallel data transfer. Supports 4-bit parallel data transfer equivalent to “Memory Stick PRO Duo”.

- This product is compatible with “Memory Stick Micro” (“M2”). “M2” is an abbreviation for “Memory Stick Micro”.
- A “Memory Stick Duo” formatted with a computer is not guaranteed to operate with the camera.
- Data read/write speeds differ depending on the combination of the “Memory Stick Duo” and the equipment used.
- Do not remove the “Memory Stick Duo” while reading or writing data.

- Data may be corrupted in the following cases:
 - When the “Memory Stick Duo” is removed or the camera is turned off during a read or write operation.
 - When the “Memory Stick Duo” is used in locations subject to static electricity or electrical noise.
- We recommend backing up important data on a hard disk of your computer.
- Do not press down hard when you write down on the memo area.
- Do not attach a label on the “Memory Stick Duo” itself nor on a Memory Stick Duo Adaptor.
- When you carry or store the “Memory Stick Duo”, put it in the case supplied with it.
- Do not touch the terminal section of the “Memory Stick Duo” with your hand or a metal object.
- Do not strike, bend or drop the “Memory Stick Duo”.
- Do not disassemble or modify the “Memory Stick Duo”.
- Do not expose the “Memory Stick Duo” to water.
- Do not leave the “Memory Stick Duo” within the reach of small children. They might accidentally swallow it.
- Do not insert anything other than a “Memory Stick Duo” into the Memory Stick Duo slot. Otherwise, a malfunction may result.
- Do not use or store the “Memory Stick Duo” under the following conditions:
 - High temperature locations such as the hot interior of a car parked in direct sunlight
 - Locations exposed to direct sunlight
 - Humid locations or locations with corrosive substances present

Notes on using the Memory Stick Duo Adaptor (not supplied)

- To use a “Memory Stick Duo” with a “Memory Stick” compliant device, be sure to insert the “Memory Stick Duo” into a Memory Stick Duo Adaptor. If you insert a “Memory Stick Duo” into a “Memory Stick” compliant device without a Memory Stick Duo Adaptor, you might not be able to remove it from the device.
- When inserting a “Memory Stick Duo” into a Memory Stick Duo Adaptor, make sure the “Memory Stick Duo” is inserted facing in the correct direction, then insert it all the way in. Incorrect insertion may result in a malfunction.
- When using a “Memory Stick Duo” inserted into a Memory Stick Duo Adaptor with a “Memory Stick” compliant device, make sure that the Memory Stick Duo Adaptor is inserted facing the correct direction. Note that improper use may damage the equipment.
- Do not insert a Memory Stick Duo Adaptor into a “Memory Stick” compliant device without a “Memory Stick Duo” attached. Doing so may result in malfunction of the unit.

Notes on using “Memory Stick PRO Duo” (not supplied)

“Memory Stick PRO Duo” with a capacity up to 16 GB have been confirmed to operate properly with the camera.

Notes on using “Memory Stick Micro” (not supplied)

- To use a “Memory Stick Micro” with the camera, be sure to insert the “Memory Stick Micro” into a Duo-sized “M2” Adaptor. If you insert a “Memory Stick Micro” into the camera without a Duo-sized “M2” Adaptor, you might not be able to remove it from the camera.
- Do not leave the “Memory Stick Micro” within the reach of small children. They might accidentally swallow it.

On the battery pack

On charging the battery pack

We recommend charging the battery pack in an ambient temperature of between 10°C to 30°C (50°F to 86°F). The battery pack may not be fully charged in temperatures outside this range.

Effective use of the battery pack

- Battery performance decreases in low temperature surroundings. So in cold places, the operational time of the battery pack is shorter. We recommend the following to ensure longer battery pack use:
 - Put the battery pack in a pocket close to your body to warm it up, and insert it in the camera immediately before you start shooting.
- The battery pack will run out quickly if you use the flash or zoom frequently.
- We recommend having spare battery packs handy for two or three times the expected shooting time, and making trial shots before taking the actual shots.
- Do not expose the battery pack to water. The battery pack is not water-resistant.
- Do not leave the battery pack in extremely hot places, such as in a car or under direct sunlight.

How to store the battery pack

- Fully discharge the battery pack before storing and store it in a cool, dry place. To maintain the battery pack's function, fully charge the battery pack and then fully discharge it on the camera at least once a year while storing.
- To use the battery pack up, leave the camera in slideshow (page 38) playback mode until the power goes off.
- To prevent staining the terminal, short-circuiting, etc., be sure to use a supplied battery case when carrying and storing.

On battery life

- The battery life is limited. Battery capacity decreases over time and through repeated use. If decreased usage time between charges becomes significant, it is probably time to replace it with a new one.
- The battery life varies according to how it is stored and the operating conditions and environment in which each battery pack is used.

Compatible battery pack

- The NP-BG1 (supplied) can be used only in G type compatible Cyber-shot models.
- If you use the NP-FG1 battery pack (not supplied), the minutes also appear after the battery remaining indicator (🔋 60 Min).

On the battery charger

On the battery charger

- Do not charge any battery pack other than the NP-BG type or NP-FG type battery packs in the battery charger (supplied). Batteries other than the specified kind may leak, overheat, or explode if you attempt to charge them, posing a risk of injury from electrocution and burns.
- Remove the charged battery pack from the battery charger. If you leave the charged battery pack in the charger, battery life may be shortened.
- When the CHARGE lamp flashes, remove the battery pack being charged, and then insert the same battery pack into the battery charger again until it clicks. When the CHARGE lamp flashes again, this may indicate a battery error or that a battery pack other than the specified type has been inserted. Check that the battery pack is the specified type. If the battery pack is the specified type, remove the battery pack, replace it with new one or another one and check if the battery charger operates correctly. If the battery charger operates correctly, a battery error may have occurred.

On Cyber-shot Station

On Cyber-shot Station

The Cyber-shot Station CSS-HD2 (not supplied) is compliant to your camera.

Using the Cyber-shot Station (not supplied) enables faster charging than the supplied battery charger and easy connection to a TV.

For details, refer to the operating instructions supplied with the Cyber-shot Station.

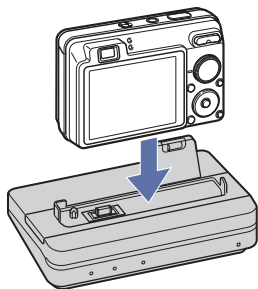



- A**
- Add / Remove Favorites 70
 - Adjusting EV 21, 55
 - AE/AF lock indicator 24, 59
 - AF Illuminator 89
 - AF lock 59
 - AF Mode 90
 - AF range finder frame 58
 - Aperture 9
 - Auto Adjustment mode 24
 - Auto Focus 7, 58
 - Auto Orientation 92
 - Auto Review 92
- B**
- B & W 65
 - Battery charger 139
 - Battery pack 138
 - Beach mode 30
 - Beep 85
 - Blur 8
 - BRK 53
 - Burst 53
- C**
- Cable for multi-use terminal 103, 116
 - Center AF 58
 - Center-weighted metering 57
 - Change REC.Folder 83
 - Clock Settings 93
 - Cloudy 60
 - Color 10
 - Color Filter 65
 - Color Mode 64
 - Color Saturation 66
 - COMPONENT 87
 - Computer 98
 - Copying images 103, 111
 - Macintosh 111
 - Recommended environment 99, 111
 - Software 100
 - Viewing image files stored on a computer with the camera 109
 - Windows 98
 - Connecting
 - Computer 103
 - Printer 116
 - TV 95
 - Contrast 66
 - Conversion Lens 91
 - Copy 83
 - Copying images to your computer 103
 - Create REC.Folder 82
 - Cross Filter 74
- D**
- Date 93
 - Date List 69
 - Date View 68
 - Daylight 60
 - Delete 42, 69
 - Format 82, 84
 - Deleting images 42
 - Digital Zoom 90
 - DirectX 100
 - DISP 20
 - Download Music 110
 - DPOF 78, 118
 - DRO 63
- E**
- Easy Shooting mode 25
 - EV 55
 - Exposure 9
 - Exposure Bracket 53
 - Extension 109
 - Extra High Sensitivity mode 29
 - Extra High-speed Burst mode 29
- F**
- Face Detection 51
 - Favorites 68
 - File name 105
 - File storage destination 105
 - Filter by Faces 70
 - Fireworks mode 30
 - Fisheye Lens 74
 - Flash (White Balance) 61
 - Flash forced off 26
 - Flash forced on 26
 - Flash Level 62
 - Flash mode 26, 50
 - Fluorescent Light 1, 2, 3 60
 - Focus 7, 25, 58
 - Folder
 - Changing 83
 - Creating 82
 - Selecting 79
 - Folder View 68
 - Format 82, 84
 - Format Music 110
 - Function Guide 85
- G**
- Grid Line 89
- H**
- Happy Faces 75
 - HD(1080i) 87
 - High Sensitivity mode 29
 - Histogram 20, 21

- Holding the camera 24
- HOME 44
- I**
- Identifying parts 14
- Image file storage destinations and file names 105
- Image quality 11
- Image Size 11, 49
- Incandescent 60
- Index screen 37
- Indicator 16
- Initialize 85
- Install 100
- Internal memory 22
- Internal Memory Tool 84
- ISO 9, 10, 56
- J**
- JPG 106
- L**
- Landscape mode 30
- Language Setting 94
- LCD Screen 20
- M**
- Macintosh computer 111
 - Recommended environment 111
- Macro 26
- Main Settings 1 85
- Main Settings 2 87
- Manage Memory 82
- Manual Exposure mode 34
- Mass Storage 87
- “Memory Stick Duo” 136
- Memory Stick Tool 82
- Menu
 - Items 47
 - Viewing 69
- Metering Mode 57
- Mode Dial 23
- Monitor 90
- MPG 106
- MTP 87
- Multi AF 58
- Multi Connector... 95, 103, 116
- Multi-pattern metering 57
- Multi-Purpose Resize 76
- Music Tool 110
- Music Transfer 110, 112
- N**
- Noise Reduction 64
- NR slow shutter 17
- NTSC 88
- O**
- One Push 61
- One Push Set 61
- Optical zoom 25, 90
- OS 99, 111
- Overexposure 9
- P**
- PAL 88
- Partial Color 73
- PC 98
- PictBridge 87, 115
- Picture Motion Browser 102
- Pixel 11
- Playback zoom 36
- Precision Digital Zoom 90
- Pressing halfway down 7
- Print 78, 114
- Print order mark 78, 118
- Printing at a shop 118
- Printing directly 115
- Program Auto mode 23
- Protect 77
- PTP 87
- R**
- Radial Blur 74
- Real 64
- REC Mode 53
- Red Eye Correction 72
- Red Eye Reduction 63
- Retouch 72
- Retro 75
- Rotate 78
- S**
- Scene Recognition 54
- Scene Selection 28, 49
- Screen
 - Changing the display 20
 - Indicator 16
 - LCD backlight 20
- SD 87
- Select Folder 79
- Self-diagnosis display 131
- Self-timer 27
- Semi manual 59
- Sepia 65
- Settings 85
- Sharpness 66
- Shooting
 - movie 24
 - still image 24
- Shooting Settings 1 89
- Shooting Settings 2 92
- Shutter speed 9
- Single 90
- Slideshow 38, 71
- Slow synchro 26
- Smart zoom 90

| | |
|--------------------------------------|---------------|
| Smile demo mode | 86 |
| Smile Detection | 52 |
| Smile Detection Sensitivity | 52 |
| Smile Shutter mode | 29, 32 |
| Snow mode | 30 |
| Soft Focus | 73 |
| Soft Snap mode | 29 |
| Software | 100, 102, 110 |
| Spot AF | 58 |
| Spot metering | 57 |
| Spot metering cross hairs | 57 |
| SteadyShot | 67 |

T

| | |
|------------------------------|-----|
| Trimming | 72 |
| Troubleshooting | 120 |
| TV | 95 |
| Twilight mode | 30 |
| Twilight Portrait mode | 30 |

U

| | |
|-----------------------------------|-----|
| Underexposure | 9 |
| Underwater | 31 |
| Underwater White Balance | 62 |
| Unsharp masking | 73 |
| USB Connect | 87 |
| Using the camera abroad | 135 |

V

| | |
|----------------------|--------|
| VGA | 12 |
| Video Out | 88 |
| View Mode | 68, 69 |
| Viewing images | 36 |
| Viewing menu | 69 |
| Vivid | 64 |
| Volume | 36 |

W

| | |
|------------------------------------------|-----|
| Warning indicators and messages | 131 |
| White Balance | 60 |
| Wide Zoom Display | 88 |
| Windows computer | 98 |
| Recommended environment | 99 |

Z

| | |
|------------|----|
| Zoom | 25 |
|------------|----|

Notes on the License

“C Library”, “Expat” and “zlib”, software are provided in the camera. We provide this software based on license agreements with their owners of copyright. Based on requests by the owners of copyright of these software applications, we have an obligation to inform you of the following. Please read the following sections.

Read “license1.pdf” in the “License” folder on the CD-ROM. You will find licenses (in English) of “C Library”, “Expat” and “zlib” software.

On GNU GPL/LGPL applied software

The software that is eligible for the following GNU General Public License (hereinafter referred to as “GPL”) or GNU Lesser General Public License (hereinafter referred to as “LGPL”) are included in the camera.

This informs you that you have a right to have access to, modify, and redistribute source code for these software programs under the conditions of the supplied GPL/LGPL.

Source code is provided on the web. Use the following URL to download it.

<http://www.sony.net/Products/Linux/>

We would prefer you do not contact us about the contents of source code.

Read “license2.pdf” in the “License” folder on the CD-ROM. You will find licenses (in English) of “GPL”, and “LGPL” software.

To view the PDF, Adobe Reader is needed. If it is not installed on your computer, you can download it from the Adobe Systems web page:

<http://www.adobe.com/>

Additional information on this product and answers to frequently asked questions can be found at our Customer Support Website.

<http://www.sony.net/>